

## **1.0 AUTOMATION IN MANUFACTURING**

### **MODULE-I**

*Automation* is the technology by which a process or procedure is accomplished without human assistance. It is implemented using a *program of instructions* combined with a *control system* that executes the instructions. To automate a process, power is required, both to drive the process itself and to operate the program and control system. Although automation can be applied in a wide variety of areas, it is most closely associated with the manufacturing industries.

*Automated manufacturing systems* operate in the factory on the physical product. They perform operations such as processing, assembly, inspection, or material handling, in some cases accomplishing more than one of these operations in the same system. They are called automated because they perform their operations with a reduced level of human participation compared with the corresponding manual process. In some highly automated systems, there is virtually no human participation. Examples of automated manufacturing systems include:

- automated machine tools that process parts
- transfer lines that perform a series of machining operations
- automated assembly systems
- manufacturing systems that use industrial robots to perform processing or assembly operations
- automatic material handling and storage systems to integrate manufacturing operations
- automatic inspection systems for quality control

Thus, Automation is a technology concerned with the application of mechanical, electronic, and computer-based systems to operate and control production. This technology includes:

- Automatic machine tools to process parts
- Automatic assembly machines
- Industrial robots
- Automatic material handling and storage systems
- Automatic inspection systems for quality control
- Feedback control and computer process control
- Computer systems for planning, data collection, and decision making to support manufacturing activities

### **1.1 ELEMENTS OF AUTOMATED SYSTEM**

An automated system consists of three basic elements:

- (1) *power* to accomplish the process and operate the system.
- (2) a *program of instructions* to direct the process, and
- (3) a *control system* to actuate the instructions.

The relationship amongst these elements is illustrated in Figure 1.1. All systems that qualify as being automated include these three basic elements in one form or another.

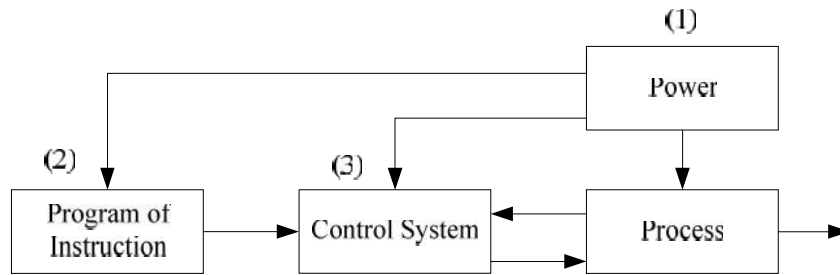

Figure 1.1 Elements of an automated system

### (1) Power to accomplish the automated process

An automated system is used to operate some process, and power is required to drive the process as well as the controls. The principal source of power in automated systems is electricity. Electric power has many advantages in automated as well as non-automated processes

- Electrical power is widely available at moderate cost.
- Electrical power can be readily converted to alternative energy forms: mechanical, thermal, light, acoustic, hydraulic, and pneumatic.
- Electrical power at low levels can be used to accomplish functions such as signal, transmission, information processing, and data storage and communication.
- Electrical energy can be stored in long-life batteries for use in locations where an external source of electrical power is not conveniently available.

Power is required in automation for the followings:

- Processing operations
- Loading and unloading the work unit
- Material transport between operations
- Controller unit
- Power to actuate the control signals
- Data acquisition and information processing

### (2) Program of Instructions

The actions performed in an automated process are defined by a program of instructions. Each part or product style made in the operation requires one or more processing steps that are unique to that style. These processing steps are performed during a work cycle. A new part is completed during each work cycle (in some manufacturing operations, more than one part is produced during the work cycle; e.g., a plastic injection molding operation may produce multiple parts each cycle using a multiple cavity mold). The particular processing steps for the work cycle are specified in a *work cycle program*.

*Work Cycle Programs.* In the simplest automated processes, the work cycle consists of essentially one step, which is to maintain a single process parameter at a defined level. However, the system becomes complicated when the process involves a work cycle consisting of multiple steps with more number of process parameters are required to be controlled. Most discrete part manufacturing operations are in this category.

*Process parameters* are inputs to the process such as temperature setting of a furnace, coordinate axis value in a positioning system, valve opened or closed in a fluid flow system, and motor on or off. Process parameters are distinguished from *process variables*, which are outputs from the process; for example, the actual temperature of the furnace, the actual position of the axis, the actual flow rate of the fluid in the pipe, and the rotational speed of the motor. As our list of examples suggests, the changes in process parameter values may be continuous (gradual changes during the processing step; for example, gradually increasing temperature during a heat treatment cycle) or discrete (stepwise changes; for example, on/off).

The work cycle may include manual steps, where the operator performs certain activities during the work cycle and the automated system performs the rest. A common example is the loading and unloading of parts by the operator to and from a numerical control machine between machining cycles where the machine performs the cutting operation under part program control. Initiation of the cutting operation of each cycle is triggered by the operator activating a "start" button after the part has been loaded.

*Decision-Making in the Programmed Work Cycle.* In automated work cycles the only two features are (1) the number and sequence of processing steps and (2) the process parameter changes in each step. Each work cycle consists of the same steps and associated process parameter changes with no variation from one cycle to the next. The program of instructions is repeated each work cycle without deviation. In fact, many automated manufacturing operations require decisions to be made during the programmed work cycle to cope with variations in the cycle. In many cases, the variations are routine elements of the cycle, and the corresponding instructions for dealing with them are incorporated into the regular part program. These cases include:

- *Operator interaction.* Although the program of instructions is intended to be carried out without human interaction, the controller unit may require input data from a human operator in order to function.
- *Different part or product styles processed by the System.* In this instance, the automated system is programmed to perform different work cycles on different part or product styles.
- *Variations in the starting work units.* In many manufacturing operations the starting work units are not consistent. A good example is a sand casting as the starting work unit in a machining operation. The dimensional variations in the raw castings sometimes necessitate an extra machining pass to bring the machined dimension to the specified value. The part program must be coded to allow for the additional pass when necessary.

In all of these examples, the routine variations can be accommodated in the regular *work cycle* program. The program can be designed to respond to sensor or operator inputs by executing the appropriate subroutine corresponding to the input. In other cases, the variations in the work cycle are not routine at all. They are infrequent and unexpected, such as the failure of an equipment component. In these instances, the program must include contingency procedures or modifications in the sequence to cope with conditions that lie outside the normal routine.

### **(3) Control System**

The control element of the automated system executes the program of instructions. The control system causes the process to accomplish its defined function which is to carry out some manufacturing operation. The controls in an automated system can be either closed loop

or open loop. A *closed loop control system*, also known as a *feedback control system* is one in which the output variable is compared with an input parameter, and any difference between the two is used to drive the output into agreement with the input. As shown in Figure 1.2, a closed loop control system consists of six basic elements: (1) input parameter, (2) process, (3) output variable, (4) feedback sensor, (5) controller and (6) actuator.

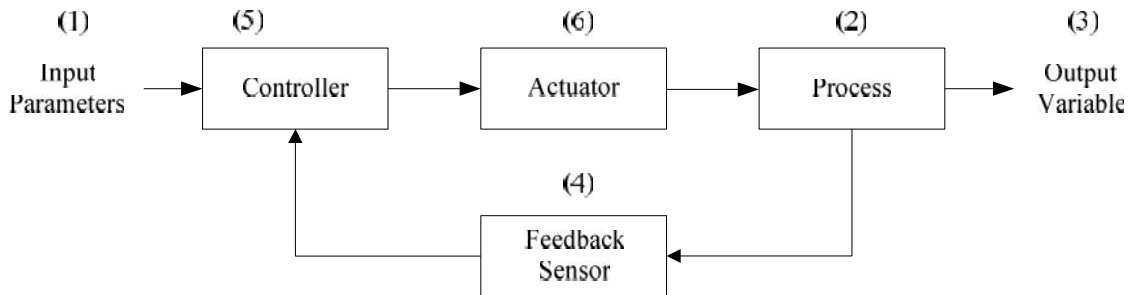

Figure 1.2 A feedback control system

The *input parameter* often referred to as the *set point*, represents the desired value of the output. The *process* is the operation or function being controlled. In particular, it is the *output variable* that is being controlled in the loop. A *sensor* is used to measure the output variable and close the loop between input and output. Sensors perform the feedback function in a closed loop control system. The controller compares the output with the input and makes the required adjustment in the process to reduce the difference between them. The adjustment is accomplished using one or more *actuators*, which are the hardware devices that physically carry out the control actions, such as an electric motor or a flow valve. The model in Figure 2 shows only one loop, however, most industrial processes require multiple loops, one for each process variable that must be controlled

In contrast to the closed loop control system, an *open loop control system* operates without the feedback loop, as in Figure 1.3. In this case, the controls operate without measuring the output variable so no comparison is made between the actual value of the output and the desired input parameter. The controller relies on an accurate model of the effect of its actuator on the process variable. With an open loop system, there is always the risk that the actuator will not have the intended effect on the process, and that is the disadvantage of an open loop system. Its advantage is that it is generally simpler and less expensive than a closed loop system. Open loop systems are usually appropriate when the following conditions apply: (1) The actions performed by the control system are simple, (2) the actuating function is very reliable, and (3) any reaction forces opposing the actuation are small enough to have no effect on the actuation. If these characteristics are not applicable, then a closed loop control system may be more appropriate.

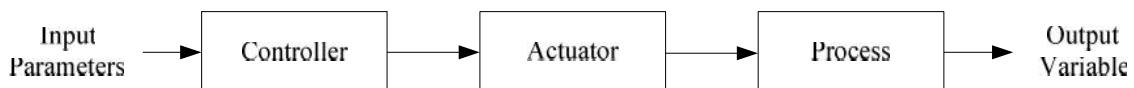

Figure 1.3 An open loop control system

### 1.3 ADVANCED AUTOMATION FUNCTIONS

In addition to executing work cycle programs, an automated system may be capable of executing advanced functions that are not specific to a particular work unit. In general, the functions are concerned with enhancing the performance and safety of the equipment. Advanced automation functions include the following: (1) safety monitoring, (2) maintenance and repair diagnostics, and (3) error detection and recovery.

Advanced automation functions are made possible by special subroutines included in the program of instructions. In some cases, the functions provide information only and do not involve any physical actions by the control system. An example of this case includes reporting a list of preventive maintenance tasks that should be accomplished. Any actions taken on the basis of this report are decided by the human operators and managers of the system and not by the system itself. In other cases, the program of instructions must be physically executed by means of the control system using available actuators. A simple example of this case is a safety monitoring system that sounds an alarm when a human worker gets dangerously close to the automated system.

#### (1) Safety Monitoring

One of the significant reasons for automating a manufacturing operation is to remove worker(s) from a hazardous working environment. An automated system is often installed to perform a potentially dangerous operation that would otherwise be accomplished manually by human workers. However, even in automated systems workers are still needed to service the system at periodic time intervals If not full-time. Accordingly, it is important that the automated system be designed to operate safely when workers are in attendance. In addition it is essential that the automated system carry out its process in a way that is not self-destructive. Thus there are two reasons for providing an automated system with a safety monitoring capability: (1) to protect human workers in the vicinity of the system and (2) to protect the equipment associated with the system. It should be mentioned that a given safety monitoring system is limited in its ability to respond to hazardous conditions by the possible irregularities that have been foreseen by the system designer. If the designer has not anticipated a particular hazard, and consequently has not provided the system with the sensing capability to detect that hazard, then the safety monitoring system cannot recognize the event if and when it occurs.

#### (2) Maintenance and Repair Diagnostics

Modern automated production systems are becoming increasingly complex and sophisticated, thus complicating the problem of maintaining and repairing them. *Maintenance and repair diagnostics* refers to the capabilities of an automated system to assist in the identification of the source of potential or actual malfunctions and failures of the system. Three modes of operation are typical of a modern maintenance and repair diagnostics subsystem.

- *Status monitoring*: In the status monitoring mode, the diagnostic subsystem monitors and records the status of key sensors and parameters of the system during normal operation. On request, the diagnostics subsystem can display any of these values and provide an interpretation of current system status, perhaps warning of an imminent failure.
- *Failure diagnostics*: The failure diagnostics mode is invoked when a malfunction or failure occurs. Its purpose is to interpret the current values of the monitored values and to analyze the recorded values preceding the failure so that the cause of the failure can be identified.
- *Recommendation of repair procedure*: The subsystem provides a recommended procedure to the repair crew as to the steps that should be taken to effect repairs.

Methods for developing the recommendations are sometimes based on the use of expert systems in which the collective judgments of many repair experts are pooled and incorporated into a computer program that uses artificial intelligence techniques.

Status monitoring serves two important functions in machine diagnostics: (1) providing information for diagnosing a current failure and (2) providing data to predict a future malfunction or failure. First, when a failure of the equipment has occurred, it is usually difficult for the repair crew to determine the reason for the failure and what steps should be taken to make repairs. It is often helpful to reconstruct the events leading up to the failure. The computer is programmed to monitor and record the variables and to draw logical inferences from their values about the reason for the malfunction. This diagnosis helps the repair personnel make the necessary repairs and replace the appropriate components.

This is especially helpful in electronic repairs where it is often difficult to determine on the basis of visual inspection which components have failed. The second function of status monitoring is to identify signs of an impending failure, so that the affected components can be replaced before failure actually causes the system to go down. These part replacements can be made during the night shift or other time when the process is not operating with the result that the system experiences no loss of regular operation.

### **(3) Error Detection and recovery**

In the operation of any automated system, there are hardware malfunctions and unexpected events that occur during operation. These events can result in costly delays and loss of production until the problem has been corrected and regular operation is restored. Traditionally equipment malfunctions are corrected by human workers, perhaps with the aid of maintenance and repair diagnostics subroutine. With the increased use of computer control for manufacturing processes, there is a trend toward using the control computer not only to diagnose the malfunctions but also to automatically take the necessary corrective action to restore the system to normal operation. The term *error detection and recovery* is used when the computer performs these functions,

*Error Detection:* As indicated by the term error detection and recovery consists of two steps: (1) error detection and (2) error recovery. The *error defection* step uses the automated system's available sensor systems to determine when a deviation or malfunction has occurred, correctly interpret the sensor signal(s), and classify-the error. Design of the error detection subsystem must begin with the classification of the possible errors that can occur during system operation. The errors in a manufacturing process tend to be very application specific. They must be anticipated in advance in order to select sensors that will enable their detection

In analyzing a given production operation, the possible errors can be classified into one of three general categories:

- (1) random errors,
- (2) systematic errors, and
- (3) aberrations,

*Random errors* occur as a result of the normal stochastic nature of the process. These errors occur when the process is in statistical control. Large variations in part dimensions, even when the production process is in statistical control, can cause problems in downstream operations. By detecting these deviations on a part-by-part basis, corrective action can be taken in subsequent operations.

*Systematic errors* are those that result from some assignable cause such as a change in raw material properties or a drift in an equipment setting. These errors usually cause the product to deviate from specifications so as to be unacceptable in quality terms.

The third type of error *aberrations*, results from either an equipment failure or a human mistake. Examples of equipment failures include fracture of a mechanical shear pin, bursts in a hydraulic line, rupture of a pressure vessel, and sudden failure of a cutting tool. Examples of human mistakes include errors in the control program, improper fixture setups, and substitution of the wrong raw materials,

The two main design problems in error detection are: (1) to anticipate all of the possible errors that can occur in a given process and (2) to specify the appropriate sensor systems and associated interpretive software so that the system is capable of recognizing each error. Solving the first problem requires a systematic evaluation of the possibilities under each of the three error classifications. If the error has not been anticipated, then the error detection subsystem cannot correctly detect and identify it.

*Error recovery*: It is concerned with applying the necessary corrective action to overcome the error and bring the system back to normal operation. The problem of designing an error recovery system focuses on devising appropriate strategies and procedures that will either correct or compensate for the variety of errors that can occur in the process. Generally, a specific recovery strategy and procedure must be designed for each different error. The types of strategies can be classified as follows:

1. *Make adjustments at the end of the current work cycle.* When the current work cycle is completed, the part program branches to a corrective action subroutine specifically designed for the error detected, executes the subroutine, and then returns to the work cycle program. This action reflects a low level of urgency and is most commonly associated with random errors in the process.
2. *Make adjustments during the current cycle.* This generally indicates a higher level of urgency than the preceding type. In this case, the action to correct or compensate for the detected error is initiated as soon as the error is detected. However, it must be possible to accomplish the designated corrective action while the work cycle is still being executed.
3. *Stop the process to invoke corrective action.* In this case, the deviation or malfunction requires that the execution of the work cycle be suspended during corrective action. It is assumed that the system is capable of automatically recovering from the error without human assistance. At the end of the corrective action, the regular work cycle is continued.
4. *Stop the process and call for help.* In this case, the error requiring stoppage of the process that cannot be resolved through automated recovery procedures. This situation arises because: (1) the automated cell is not enabled to correct the problem or (2) the error cannot be classified into the predefined list of errors. In either case, human assistance is required to correct the problem and restore the system to fully automated operation.

Error detection and recovery requires an interrupt system. When an error in the process is sensed and identified, an interrupt in the current program execution is invoked to branch to the appropriate recovery subroutine, This is done either at the end of the current cycle (type 1 above) or immediately (types 2, 3, and 4).At the completion of the recovery procedure, program execution reverts back to normal operation.

## 1.4 LEVELS OF AUTOMATION

The concept of automated systems can be applied to various levels of factory operations. One normally associates automation with the individual production machines. However, the production machine itself is made up of subsystems that may themselves be automated.

For example, a modern numerical control (NC) machine tool is an automated system. However, the NC machine itself is composed of multiple control systems. Similarly, a NC machine is often part of a larger manufacturing system, and the larger system may itself be automated. Thus there are various levels of automation is depicted in Figure 1.4.

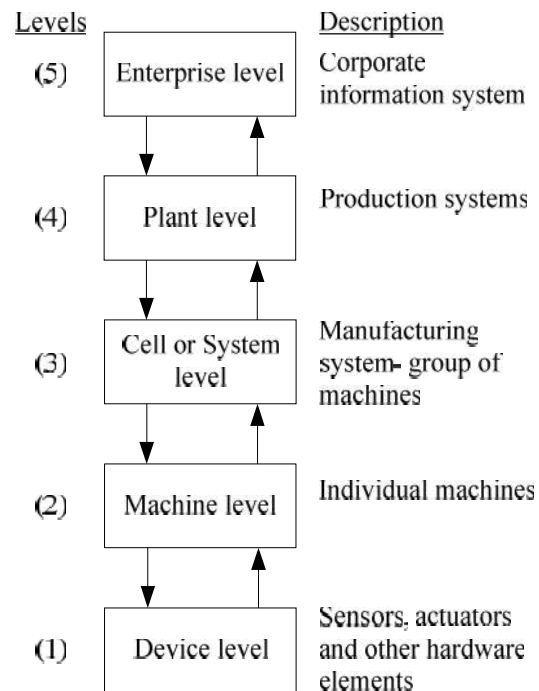

Figure 1.4 Level of automation

1. *Device level.* This is the lowest level in automation hierarchy. It includes the actuators, sensors, and other hardware components that comprise the machine level. The devices are combined into the individual control loops of the machine; for example, the feedback control loop for one axis of a CNC machine or one joint of an industrial robot.
2. *Machine level.* Hardware at the device level is assembled into individual machines. Examples include CNC machine tools and similar production equipment, industrial robots, powered conveyors, and automated guided vehicles. Control functions at this level include performing the sequence of steps in the program of instructions in the correct order and making sure that each step is properly executed.
3. *Cell or system level.* This is the manufacturing cell or system level, which operates under instructions from the plant level. A manufacturing cell or system is a group of machines or workstations connected and supported by a material handling system, computer and other equipment appropriate to the manufacturing process. Production lines are included in this level. Likely functions include part dispatching and machine loading, coordination among machines and material handling system, and collecting and evaluating inspection data.



4. *Plant level.* This is the factory or production systems level. It receives instructions from (he corporate information system and translates them into operational plans for production. Likely functions include: order processing, process planning, inventory control, purchasing, material requirements planning, shop floor control, and quality control.
5. *Enterprise level.* This is the highest level consisting of the corporate information system. It is concerned with all of the functions necessary to manage the company: marketing and sales, accounting, design, research, aggregate planning, and master production scheduling.

## 1.5 TYPES OF AUTOMATION

Automated production systems are classified into three basic types:

1. Fixed automation
2. Programmable automation
3. Flexible automation

### **Fixed automation**

Fixed automation is a system in which the sequence of processing (or assembly) operations is fixed by the equipment configuration. The operations in the sequence are usually simple. It is the integration and coordination of many such operations into one piece of equipment that makes the system complex. The typical features of fixed automation are:

- High initial investment for custom-engineered equipment
- High production rates
- Relatively inflexible in accommodating product changes

The economic justification for fixed automation is found in products with very high demand rates and volumes. The high initial cost of the equipment can be spread over a very large number of units, thus making the unit cost attractive compared to alternative methods of production.

### **Programmable automation**

In programmable automation, the production equipment is designed with the capability to change the sequence of operations to accommodate different product configurations. The operation sequence is controlled by a program, which is a set of instructions coded so that the system can read and interpret them. New programs can be prepared and entered into the equipment to produce new products. Some of the features that characterize programmable automation include:

- High investment in general-purpose equipment
- Low production rates relative to fixed automation
- Flexibility to deal with changes in product configuration
- Most suitable for batch production

Automated production systems that are programmable are used in low and medium- volume production. The parts or products are typically made in batches. To produce each new batch of a different product, the system must be reprogrammed with the set of machine instructions that correspond to the new product. The physical setup of the machine must also be changed over: Tools must be loaded, fixtures must be attached to the machine table, and the required machine settings must be entered. This changeover procedure takes time. Consequently, the

typical cycle for a given product includes a period during which the setup and reprogramming takes place, followed by a period in which the batch is produced.

### Flexible automation

Flexible automation is an extension of programmable automation. The concept of flexible automation has developed only over the last 15 to 20 years, and the principles are still evolving. A flexible automated system is one that is capable of producing a variety of products (or parts) with virtually no time lost for changeovers from one product to the next. There is no production time lost while reprogramming the system and altering the physical setup (tooling, fixtures and machine settings). Consequently, the system can produce various combinations and schedules of products, instead of requiring that they be made in separate batches. The features of flexible automation can be summarized as follows:

- High investment for a custom-engineered system
- Continuous production of variable mixtures of products
- Medium production rates
- Flexibility to deal with product design variations

The essential features that distinguish flexible automation from programmable automation are (1) the capacity to change part programs with no lost production time, and (2) the capability to change over the physical setup, again with no lost production time. These features allow the automated production system to continue production without the downtime between batches that is characteristic of programmable automation. Changing the part programs is generally accomplished by preparing the programs offline on a computer system and electronically transmitting the programs to the automated production system. Therefore, the time required to do the programming for the next job does not interrupt production on the current job. Changing the physical setup between parts is accomplished by making the changeover offline and then moving it into place simultaneously as the next part comes into position for processing. The use of pallet fixtures that hold the parts and transfer into position at the workplace is one way of implementing this approach. For these approaches to be successful, the variety of parts that can be made on a flexible automated production system is usually more limited than a system controlled by programmable automation.

The relative positions of the three types of automation for different production volumes and product varieties are depicted in Figure 1.5.

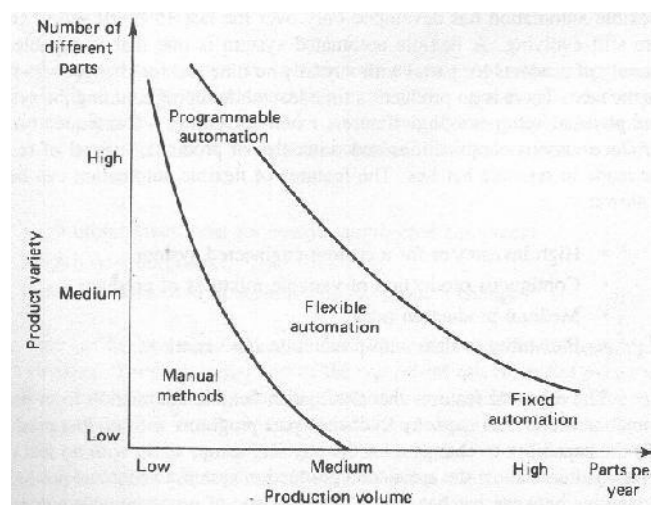

Figure 1.5 Types of automation as a function of volume of production versus product variety

## 1.6 REASONS FOR AUTOMATING

The important reasons for automating include the following:

1. *Increased productivity:* Automation of manufacturing operations holds the promise of increasing the productivity of labor. This means greater output per hour of labor input. Higher production rates (output per hour) are achieved with automation than with the corresponding manual operations.
2. *High cost of labor:* The trend in the industrialized societies of the world has been toward ever-increasing labor costs. As a result, higher investment in automated equipment has become economically justifiable to replace manual operations. The high cost of labor is forcing business leaders to substitute machines for human labor. Because machines can produce at higher rates of output, the use of automation results in a lower cost per unit of product.
3. *Labor shortages:* In many advanced nations there has been a general shortage of labor. Labor shortages also stimulate the development of automation as a substitute for labor.
4. *Trend of labor toward the service sector:* This trend has been especially prevalent in the advanced countries. First around 1986, the proportion of the work force employed in manufacturing stands at about 20%. In 1947, this percentage was 30%. By the year 2000, some estimates put the figure as low as 2%, certainly, automation of production jobs has caused some of this shift. The growth of government employment at the federal, state, and local levels has consumed a certain share of the labor market which might otherwise have gone into manufacturing. Also, there has been a tendency for people to view factory work as tedious, demeaning, and dirty. This view has caused them to seek employment in the service sector of the economy.
5. *Safety:* By automating the operation and transferring the operator from an active participation to a supervisory role, work is made safer. The safety and physical well-being of the worker has become a national objective with the enactment of the Occupational Safety and Health Act of 1970 (OSHA). It has also provided an impetus for automation.
6. *High cost of raw materials:* The high cost of raw materials in manufacturing results in the need for greater efficiency in using these materials. The reduction of scrap is one of the benefits of automation.
7. *Improved product quality:* Automated operations not only produce parts at faster rates than do their manual counterparts, but they produce parts with greater consistency and conformity to quality specifications.
8. *Reduced manufacturing lead time:* For reasons that we shall examine in subsequent chapters, automation allows the manufacturer to reduce the time between customer order and product delivery. This gives the manufacturer a competitive advantage in promoting good customer service.
9. *Reduction of in-process inventory:* Holding large inventories of work-in-process represents a significant cost to the manufacturer because it ties up capital. In-process

inventory is of no value. It serves none of the purposes of raw materials stock or finished product inventory. Accordingly, it is to the manufacturer's advantage to reduce work-in-progress to a minimum. Automation tends to accomplish this goal by reducing the time a workpart spends in the factory.

10. *High cost of not automating*: A significant competitive advantage is gained by automating a manufacturing plant. The advantage cannot easily be demonstrated on a company's project authorization form. The benefits of automation often show up in intangible and unexpected ways, such as improved quality, higher sales, better labor relations, and better company image. Companies that do not automate are likely to find themselves at a competitive disadvantage with their customers, their employees, and the general public.

All of these factors act together to make production automation a feasible and attractive alternative to manual methods of manufacture.

## 1.7 TYPES OF PRODUCTION

Another way of classifying production activity is according to the quantity of product made. In this classification, there are three types of production:

1. Job shop production
  2. Batch production
  3. Mass production
1. *Job shop production*: The distinguishing feature of job shop production is low volume. The manufacturing lot sizes are small, often one of a kind. Job shop production is commonly used to meet specific customer orders, and there is a great variety in the type of work the plant must do. Therefore, the production equipment must be flexible and general purpose to allow for this variety of work. Also, the skill level of job shop workers must be relatively high so that they can perform a range of different work assignments. Examples of products manufactured in a job shop include space vehicles, aircraft, machine tools, special tools and equipment, and prototypes of future products. Construction work and shipbuilding are not normally identified with the job shop category, even though the quantities are in the appropriate range. Although these two activities involve the transformation of raw materials into finished products, the work is not performed in a factory.
  2. *Batch production*: This category involves the manufacture of medium-sized lots of the same item or product. The lots may be produced only once, or they may be produced at regular intervals. The purpose of batch production is often to satisfy continuous customer demand for an item. However, the plant is capable of a production rate that exceeds the demand rate. Therefore, the shop produces to build up an inventory of the item. Then it changes over to other orders. When the stock of the first item becomes depleted, production is repeated to build up the inventory again. The manufacturing equipment used in batch production is general-purpose but designed for higher rates of production. Examples of items made in batch-type shops include industrial equipment, furniture, textbooks, and component parts for many assembled consumer products (household appliances, lawn mowers, etc.). Batch production plants include machine shops, casting

foundries, plastic molding factories, and press working shops. Some types of chemical plants are also in this general category.

3. *Mass production*: This is the continuous specialized manufacture of identical products. Mass production is characterized by very high production rates, equipment that is completely dedicated to the manufacture of a particular product, and very high demand rates for the product. Not only is the equipment dedicated to one product, but the entire plant is often designed for the exclusive purpose of producing the particular product. The equipment is special-purpose rather than general-purpose. The investment in machines and specialized tooling is high. In a sense, the production skill has been transferred from the operator to the machine. Consequently, the skill level of labor in a mass production plant tends to be lower than in a batch plant or job shop.

## 1.8 FUNCTIONS IN MANUFACTURING

For any of the three types of production, there are certain basic functions that must be carried out to convert raw materials into finished product. For a firm engaged in making discrete products, the functions are:

1. Processing
2. Assembly
3. Material handling and storage
4. Inspection and test
5. Control

The first four of these functions are the physical activities that "touch" the product as it is being made. Processing and assembly are operations that add value to the product. The third and fourth functions must be performed in a manufacturing plant, but they do not add value to the product. The Figure 1.6 shows the model of the functions of manufacturing in factory.

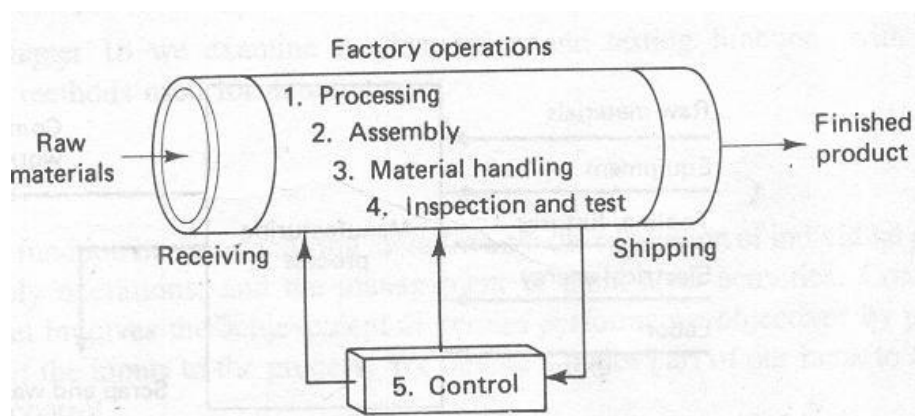

Figure 1.6 Model of the factory showing five functions of manufacturing

### (1) Processing operations

Processing operations transform the product from one state of completion into a more advanced state of completion. Processing operations can be classified into one of the following four categories:

1. Basic processes
2. Secondary processes

3. Operations to enhance physical properties
4. Finishing operations

*Basic processes* are those which give the work material its initial form. Metal casting and plastic molding are examples. In both cases, the raw materials are converted into the basic geometry of the desired product.

*Secondary processes* follow the basic process and are performed to give the work part its final desired geometry. Examples in this category include machining (turning, drilling, milling, etc.) and press working operations (blanking, forming, drawing, etc.).

*Operations to enhance physical properties* do not perceptibly change the physical geometry of the work part. Instead, the physical properties of the material are improved in some way. Heat-treating operations to strengthen metal pans and preshrinking used in the garment industry are examples in this category.

*Finishing operations* are the final processes performed on the work part. Their purpose is, for example, to improve the appearance, or to provide a protective coating on the part. Examples in this fourth category include polishing, painting, and chrome plating.

Figure 6 presents an input/output model of a typical processing operation in manufacturing. Most manufacturing processes require five inputs:

1. Raw materials
2. Equipment
3. Tooling, fixtures
4. Energy (electrical energy)
5. Labor

#### *(2) Assembly operations*

Assembly and joining processes constitute the second major type of manufacturing operation. In assembly, the distinguishing feature is that two or more separate components are joined together. Included in this category are mechanical fastening operations, which make use of screws, nuts, rivets, and so on, and joining processes, such as welding, brazing, and soldering. In the fabrication of a product, the assembly operations follow the processing operations.

#### *(3) Material handling and storage*

A means of moving and storing materials between the processing and assembly operations must be provided. In most manufacturing plants, materials spend more time being moved and stored than being processed. In some cases, the majority of the labor cost in the factory is consumed in handling, moving, and storing materials. It is important that this function be carried out as efficiently as possible.

#### *(4) Inspection and testing*

Inspection and testing are generally considered part of quality control. The purpose of inspection is to determine whether the manufactured product meets the established design standards and specifications. For example, inspection examines whether the actual dimensions of a mechanical part are within the tolerances indicated on the engineering drawing for the part and testing is generally concerned with the functional specifications of the final product rather than the individual parts that go into the product.

### (5) Control

The control function in manufacturing includes both the regulation of individual processing and assembly operations, and the management of plant-level activities. Control at the process level involves the achievement of certain performance objectives by proper manipulation of the inputs to the process. Control at the plant level includes effective use of labor, maintenance of the equipment, moving materials in the factory, shipping products of good quality on schedule, and keeping plant operating costs at the minimum level possible. The manufacturing control function at the plant level represents the major point of intersection between the physical operations in the factory and the information processing activities that occur in production.

## 1.8 PRODUCTION CONCEPTS AND MATHEMATICAL MODELS

A number of production concepts are quantitative, or require a quantitative approach to measure them.

### (1) Manufacturing lead time

Production consists of a series of individual steps: processing and assembly operations. Between the operations are material handling, storage, inspections, and other nonproductive activities. Therefore, the activities in production are divided into two main categories, operations and non-operation elements. An operation on a product (or work part) takes place when it is at the production machine. The non-operation elements are the handling, storage, inspections, and other sources of delay. Let;

$T_o$  = Time per operation at a given machine or workstation

$T_{no}$  = Non operation time associated with the same machine

$n_m$  = Number of separate machines or operations through which the product must be routed in order to be completely processed.

$Q$  = Units of the product in the batch (for batch production)

$T_{su}$  = Setup time

The *manufacturing lead lime* (MLT) is the total time required to process a given product (or work part) through the plant. It can be expressed as:

$$MLT = \sum_{i=1}^{n_m} (T_{sui} + QT_{oi} + T_{noi})$$

Where  $i$  indicates the operation sequence in the processing,  $i = 1, 2, \dots, n$ . The MLT equation does not include the time the raw work part spends in storage before its turn in the production schedule begins.

Let us assume that all operation times, setup times, and non-operation times are equal, respectively then MLT is given by

$$MLT = n_m \sum_{i=1}^{n_m} (T_{su} + QT_o + T_{no})$$

For mass production, where a large number of units are made on a single machine, the MLT simply becomes the operation time for the machine after the setup has been completed and production begins.

For flow type mass production, the entire production line is set up in advance. Also, the non-operation time between processing steps consists simply of the time to transfer the product (or part) from one machine or workstation to the next. If the workstations are integrated so that parts are being processed simultaneously at each station, the station with the longest operation time will determine the MLT value. Hence,

$$MLT = n_m (\text{transfer time} + \text{longest } T_o)$$

In this case,  $n_m$  represents the number of separate workstations on the production line.

The values of setup time, operation time, and non-operation time are different for the different production situations. Setting up a flow line for high production requires much more time than setting up a general purpose machine in a job shop. However, the concept of how time is spent in the factory for the various situations is valid.

### Example 1

A certain part is produced in a batch size of 50 units and requires a sequence of eight operations in the plant. The average setup time is 3 h, and the average operation time per machine is 6 min. The average non operation time due to handling, delays, inspections, and so on, is 7 h. compute how many days it will take to produce a batch, assuming that the plant operates on a 7-hh shift per day.

### Solution:

The manufacturing lead time is computed from

$$MLT = n_m \sum_{i=1}^{n_m} (T_{su} + QT_o + T_{no})$$

$$MLT = 8 \sum_{i=1}^{n_m} (3 + 50 \times 0.1 + 7) = 20 \text{ hrs}$$

## (2) Production Rate

The production rate ( $R_p$ ) for an individual manufacturing process or assembly operation is usually expressed as an hourly rate (e.g. units of product per hour). Considering a batch production scenario;

$$\frac{\text{Batch time}}{\text{machine}} = T_{su} + QT_o$$

If the value of  $Q$  represents the desired quantity to be produced, and there is a significant scrap rate, denoted by  $q$ , the quantity started through the process must be  $Q/(1-q)$  and therefore the batch time becomes;

$$\frac{\text{Batch time}}{\text{machine}} = T_{su} + \frac{QT_o}{(1-q)}$$

Dividing the batch time by the quantity in the batch yield the average production time ( $T_p$ ) per unit of product for the given machine:

$$T_p = \frac{\text{batch time / machine}}{Q}$$



The average production rate for the machine is simply the reciprocal of the production time:

$$R_p = \frac{1}{T_p}$$

For job shop production, if the quantity  $Q = 1$ , the production time per unit is

$$T_p = T_{su} + T_o$$

For quantity-type mass production, the production rate equals the cycle rate of the machine (reciprocal of operation time) after production has started and the effects of setup are neglected.

For flow-type mass production, the production time approximates to the cycle time of the production line (transfer time + longest operation time), again neglecting the setup time.

### ***Components of the operation time***

The operation time ( $T_o$ ) is the time an individual workpart spends on a machine, but not all of this time is productive. Let us try to relate the operation time to a specific process. Operation time for a machining operation is composed of three elements such as the actual machining time ( $T_m$ ), the workpiece handling time ( $T_h$ ), and any tool handling time per workpiece ( $T_{th}$ ). Hence,

$$T_o = T_m + T_h + T_{th}$$

The tool handling time represents all the time spent in changing tools when they wear out, changing from one tool to the next for successive operations performed on a turret lathe, changing between the drill bit and tap in a drill-and-tap sequence performed at one drill press, and so on.  $T_{th}$  is the average time per workpiece for any and all of these tool handling activities.

Each of the terms  $T_m$ ,  $T_h$  and  $T_{th}$  has its counterpart in many other types of discrete-item production operations. There is a portion of the operation cycle, when the material is actually being worked ( $T_m$ ), and there is a portion of the cycle when either the work part is being handled ( $T_h$ ) or the tooling is being adjusted or changed ( $T_{th}$ ). Therefore, the equation for operation time as mentioned above can be generalized for many manufacturing processes in addition to machining.

### **(3) Capacity**

The term *capacity*, or *plant capacity*, is used to define the maximum rate of output that a plant is able to produce under a given set of assumed operating conditions. The assumed operating conditions refer to the number of shifts per day (one, two, or three), number of days in the week (or month) that the plant operates, employment levels, whether or not overtime is included, and so on. For continuous chemical production, the plant may be operated 24 h per day, 7 days per week.

Let  $PC$  be the production capacity (plant capacity) of a given work center or group of work centers under consideration. Capacity will be measured as the number of good units produced per week. Let  $W$  is the number of work centers. A work center is a production system in the plant typically consisting of one worker and one machine. It might also be one automated machine with no worker, or several workers acting together on a production line.

It is capable of producing at a rate  $R_p$  units per hour. Each work center operates for  $H$  hours per shift.  $H$  is an average that excludes time for machine breakdowns and repairs, maintenance, operator delays, and so on. Provision for setup time is also included in  $R_p$ . Let  $S_w$  be the shifts per week. Hence, the plant capacity can be given by;

$$PC = WS_w HR_p$$

If there is a possibility that in a batch production plant, each product is routed through  $n_m$  machines, the plant capacity equation must be amended as follows:

$$PC = \frac{WS_w HR_p}{n_m}$$

Another way of using the production capacity equation is for determining how resources might be allocated to meet a certain weekly demand rate requirement. Let  $D_w$  be the demand rate for the week in terms of number of units required. Replacing  $PC$  by  $D_w$  and rearranging,

$$WS_w H = \frac{D_w n_m}{R_p}$$

Given a certain hourly production rate for the manufacturing process, the above equation indicates three possible ways of adjusting the capacity up or down to meet changing weekly demand requirements:

1. Change the number of work centers,  $W$ , in the shop. This might be done by using equipment that was formerly not in use and by hiring new workers. Over the long term, new machines might be acquired.
2. Change the number of shifts per week,  $S_w$ . For example, Saturday shifts might be authorized.
3. Change the number of hours worked per shift,  $H$ . For example, overtime might be authorized.

In cases where production rates differ, the capacity equations can be revised, summing the requirements for the different products.

$$WS_w H = \sum \frac{D_w n_m}{R_p}$$

### **Example 2**

The turret lathe section has six machines, all devoted to production of the same pad. The section operates 10 shifts per week. The number of hours per shift averages 6.4 because of operator delays and machine breakdowns. The average production rate is 17 units/h. Determine the production capacity of the turret lathe section.

### **Solution:**

$$PC = 6(10) (6.4) (17) = 6528 \text{ units/week}$$

### Example 3

Three products are to be processed through a certain type of work center. Pertinent data are given in the following table.

<i>Product</i>	<i>Weekly demand</i>	<i>Production rate (units/h)</i>
1	600	10
2	1000	20
3	2200	40

Determine the number of work centers required to satisfy this demand, given that the plant works 10 shifts per week and there are 6.5 h available for production on each work center for each shift. The value of  $n_m = 1$ .

### Solution:

<i>Product</i>	<i>Weekly demand</i>	<i>Production hours required</i>
1	600	$600/10 = 60$
2	1000	$1000/20 = 50$
3	2200	$2200/40 = 55$
Total production hours required		165

Since each work center can operate (10 shifts/week)(6.5 h) or 65 h/week, the total number of work centers is

$$W = 165/65 = 2.54 \text{ work centers} \approx 3$$

### (4) Utilization and Availability

Utilization ( $U$ ) refers to the amount of output of a production facility relative to its capacity. It can be expressed by;

$$U = \frac{\text{output}}{\text{capacity}}$$

The term can be applied to the entire plant, a single machine in the plant, or any other productive resource (e.g., labour). For convenience it is also defined as the proportion of time that the facility is operating relative to the time available under the definition of capacity. Utilization is usually expressed as percentage.

The availability is sometimes used as a measure of reliability for equipment. It is especially germane for automated production equipment. Availability is defined using two other reliability terms, the *mean time between failures* (MTBF) and the *mean time to repair* (MTTR). The MTBF indicates the average length of time between breakdowns of the piece of equipment. The MTTR indicates the average time required to service the equipment and place it back into operation when a breakdown does occur:

$$\text{Availability} = \frac{\text{MTBF} - \text{MTTR}}{\text{MTBF}}$$

#### Example 4

A production machine is operated 65 h/week at full capacity. Its production rate is 20 units/hr. During a certain week, the machine produced 1000 good parts and was idle the remaining time.

- Determine the production capacity of the machine.
- What was the utilization of the machine during the week under consideration?

#### Solution:

- The capacity of the machine can be determined using the assumed 65-h week as follows:

$$PC = 65(20) = 1300 \text{ units/week}$$

- The utilization can be determined as the ratio of the number of parts made during productive use of the machine relative to its capacity.

$$U = \frac{\text{output}}{\text{capacity}} = \frac{1000}{1300} = 0.7692 = 76.92\%$$

#### (5) Work-in-process

*Work-in-process* (WIP) is the amount of product currently located in the factory that is either being processed or is between processing operations. WIP is inventory that is in the state of being transformed from raw material to finished product. A rough measure of work-in-process can be obtained from the equation

$$WIP = \frac{PC U}{S_w H} (MLT), \text{ where WIP represents the number of units in-process.}$$

Two measures that can be used to assess the magnitude of the work-in-process problem in a given factory are the WIP ratio and the TIP ratio. The WIP ratio provides an indication of the amount of inventory-in-process relative to the work actually being processed. It is the total quantity of a given part (or assembly) in the plant or section of the plant divided by the quantity of the same part that is being processed (or assembled). The WIP ratio is therefore determined as;

$$WIP \text{ ratio} = \frac{WIP}{\text{Number of machines processing}}$$

The number of machines processing is given by;

$$\text{Numbers of machine processing} = WU \frac{QT_o}{T_{su} + QT_o}$$

The ideal WIP ratio is 1: 1, which implies that all parts in the plant are being processed. In a high-volume flow line operation, it is expected that the WIP ratio to be relatively close to 1: 1 if we ignore the raw product that is waiting to be launched onto the line and the finished product that has been completed. In a batch production shop, the WIP ratio is significantly higher, perhaps 50: 1 or higher, depending on the average batch size, nonproductive time, and other factors in the plant.

The *TIP* ratio measures the time that the product spends in the plant relative to its actual processing time. It is computed as the total manufacturing lead time for a part divided by the sum of the individual operation times for the part.

$$\text{TIP ratio} = \frac{MLT}{n_m T_o}$$

Again, the ideal TIP ratio is 1: 1, and again it is very difficult to achieve such a low ratio in practice. In an actual factory situation, the WIP and TIP ratios would not necessarily be equal, owing to the complexities and realities encountered in the real world. For example, assembled products create complications in evaluating the ratio values because of the combination of parts into one assembly.

## 1.9 AUTOMATION PRINCIPLES AND STRATEGIES

There are certain fundamental principles and strategies that can be employed to improve productivity in manufacturing operations. The approaches are (A) the USA Principle, (B) the Ten Strategies for Automation and Production Systems, and (C) an Automation Migration Strategy.

### (A) USA Principle

The USA Principle is a common sense approach to automation projects. Similar procedures have been suggested in the manufacturing and automation trade literature, but none has a more captivating title than this one. USA stands for;

1. *Understand* the existing process
2. *Simplify* the process
3. *Automate* the process.

*Understand the Existing Process.* The obvious purpose of the first step in the USA approach is to comprehend the current process in all of its details. What are the inputs? What are the outputs? What exactly happens to the work unit between input and output? What is the function of the process? How does it add value to the product? What are the upstream and downstream operations in the production sequence, and can they be combined with the process under consideration?

Some of the basic charting tools used in methods analysis are useful in this regard, such as the operation process chart and the flow process chart. Application of these tools to the existing process provides a model of the process that can be analyzed and searched for weaknesses (and strengths). The number of steps in the process, the number and placement of inspections, the number of moves and delays experienced by the work unit, and the time spent in storage can be ascertained by these charting techniques. Mathematical models of the process may also be useful to indicate relationships between input parameters and output variables. What are the important output variables? How are these output variables affected by inputs to the process, such as raw material properties, process settings, operating parameters, and environmental conditions? This information may be valuable in identifying what output variables need to be measured for feedback purposes and in formulating algorithms for automatic process control.

*Simplify the Process.* Once the existing process is understood, then the search can begin for ways to simplify. This often involves a checklist of Questions about the existing process. What is the purpose of this step or this transport? Is this step necessary? Can this step be eliminated? Is the most appropriate technology being used in this step? How can this step be simplified? Are there unnecessary steps in the process that might be eliminated without detracting from function?

*Automate the Process.* Once the process has been reduced to its simplest form, then automation can be considered. The possible forms of automation include those listed in the ten strategies discussed in the following section. An automation migration strategy might be implemented for a new product that has not yet proven itself.

### **(B) Ten Strategies for Automation**

If automation seems a feasible solution to improving productivity, quality, or other measure of performance, then the following ten strategies provide a road map to search for these improvements.

1. **Specialization of operations:** The first strategy involves the use special purpose equipment designed to perform one operation with the greatest possible efficiency. This is analogous to the concept of labor specialization, which has been employed to improve labor productivity. Reduce  $T_o$ .
2. **Combined operations:** Production occurs as a sequence of operations. Complex parts may require dozens, or even hundreds, of processing steps. The strategy of combined operations involves reducing the number of distinct production machines on workstations through which the part must be routed. Reduce  $n_m$ ,  $T_h$ , and  $T_{no}$ .
3. **Simultaneous operations:** A logical extension of the combined operations strategy is to perform at the same time the operations that are combined at one workstation. In effect, two or more processing (or assembly) operations are being performed simultaneously on the same workpart, thus reducing total processing time. Reduce  $n_m$ ,  $T_h$ ,  $T_{no}$  and  $T_o$ .
4. **Integration of operations:** Another strategy is to link several workstations into a single integrated mechanism using automated work handling devices to transfer parts between stations. In effect, this reduces the number of separate machines through which the product must be scheduled. With more than one workstation, several parts can be processed simultaneously, thereby increasing the overall output of the system. Reduce  $n_m$ ,  $T_h$ , and  $T_{no}$ .
5. **Increased flexibility:** This strategy attempts to achieve maximum utilization of equipment for job shop and medium-volume situations by using the same equipment for a variety of products. This normally translates into lower manufacturing lead time and lower work-in-process. Reduce  $T_{su}$ , MLT, WIP; increase  $U$ .
6. **Improved material handling and storage:** A great opportunity for reducing nonproductive time exists in the use of automated material handling and storage systems. Reduce  $T_{no}$ , MLT and WIP.
7. **On-line inspection:** Inspection for quality of work is traditionally performed after the process. This means that any poor-quality product has already been produced by the time it is inspected. Incorporating inspection into the manufacturing process permits corrections to the process as product is being made. This reduces scrap and brings the overall quality of product closer to the nominal specifications intended by the designer. Reduce  $T_{no}$  and  $q$ .
8. **Process control and optimization:** This includes a wide range of control schemes intended to operate the individual processes and associated equipment more efficiently. By this strategy, the individual process times can be reduced and product quality improved. Reduce  $T_o$  and  $q$ .
9. **Plant operations control:** Whereas the previous strategy was concerned with the control of the individual manufacturing process, this strategy is concerned with control at the plant level. It attempts to manage and coordinate the aggregate operations in the plant

more efficiently. Its implementation usually involves a high level of computer networking within the factory. Reduce  $T_{no}$ , MLT and increase  $U$ .

10. **Computer integrated manufacturing (CIM):** Taking the previous strategy one step further, we have the integration of factory operations with engineering design and many of the other business functions of the firm. CIM involves extensive use of computer applications, computer databases, and computer networking in the company. Reduce MLT, design time, production planning time and increase  $U$ .

### **(C) Automation Migration Strategy**

Owing to competitive pressures in the marketplace, a company often needs to introduce a new product in the shortest possible time. As mentioned previously, the easiest and least expensive way to accomplish this objective is to design a manual production method, using a sequence of workstations operating independently. The tooling for a manual method can be fabricated quickly and at low cost. If more than a single set of workstations is required to make the product in sufficient quantity, then the manual cell is replicated as many times to meet demand. If the product turns out to be successful and high future demand is anticipated, then it makes sense for the company to automate production. The improvements are often carried out in phases. Many companies have an *automation migration strategy*: that is, a formalized plan for evolving the manufacturing system, used to produce new products as demand grows. A typical automation migration strategy is the following

Phase 1: *Manual production* using single-station manned cells operating independently. This is used for introduction of the new product for reasons already mentioned: quick and low-cost tooling to get started.

Phase 2: *Automated production* using single-station automated cells operating independently. As demand for the product grows, and it becomes clear that automation can be justified, then the single stations are automated to reduce labor and increase production rate. Work units are still moved between workstations manually.

Phase 3: *Automated integrated production* using a multi-station automated system with serial operations and automated transfer of work units between stations. When the company is certain that the product will be produced in mass quantities and for several years, then integration of the single-station automated cells is warranted to further reduce labor and increase production rate.

Details of the automation migration strategy vary from company to company, depending on the types of products they make and the manufacturing processes they perform. But well managed manufacturing companies have policies like the automation migration strategy. Advantages of such a strategy include:

- It allows introduction of the new product in the shortest possible time, since production cells based on manual workstations are the easiest to design and implement.
- It allows automation to be introduced gradually (in planned phases), as demand for the product grows, engineering changes in the product are made, and time is allowed to do a thorough design job on the automated manufacturing system.
- It avoids the commitment to a high level of automation from the start, since there is always a risk that demand for the product will not justify it.

## 1.10 COSTS IN MANUFACTURING

Decisions on automation and production systems are usually based on the relative costs of alternatives. Manufacturing costs can be classified into two major categories: (1) fixed costs and (2) variable costs.

A *fixed cost* is one that remains constant for any level of production output which includes the cost of the factory building and production equipment, insurance, and property taxes. All of the fixed costs can be expressed as annual amounts. Expenses such as insurance and property taxes occur naturally as annual costs. Capital investments such as building and equipment can be converted to their equivalent uniform annual costs using interest rate factors.

A *variable cost* is one that varies in proportion to the level of production output. As the output increases, variable cost increases. Examples include direct labor, raw materials, and electric power to operate the production equipment. The ideal concept of variable cost is that it is directly proportional to output level. When fixed cost and variable cost are added, we have the following total cost equation:

$$TC = FC + VC(Q)$$

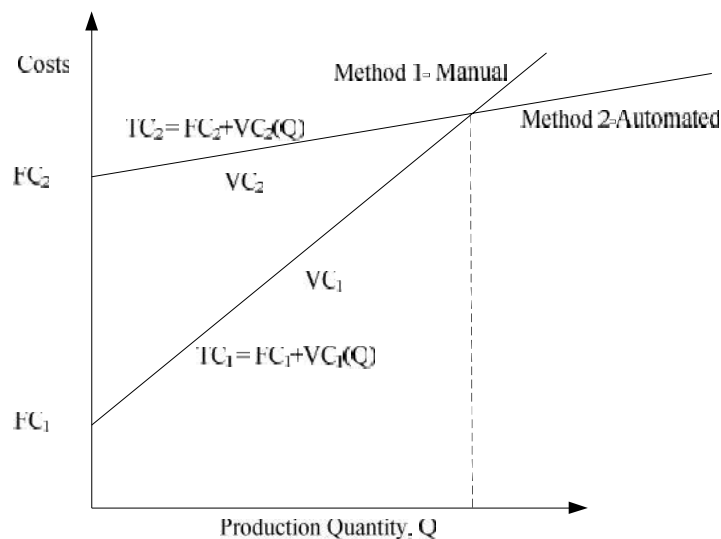

Figure 1.7 Fixed and variable costs as a function of production output for manual and automated production methods.

where  $TC$  = total annual cost (Rs./yr),  $FC$  = fixed annual cost (Rs./yr),  $VC$  = variable cost (Rs./pc), and  $Q$  = annual quantity produced (pc/yr).

When comparing automated and manual production methods, it is typical that the fixed cost of the automated method is high relative to the manual method, and the variable cost of automation is low relative to the manual method, as pictured in Figure 1.7. Consequently, the manual method has a cost advantage in the low quantity range, while automation has an advantage for high quantities.

### Direct labor, Material, and Overhead



Fixed versus variable are not the only possible classifications of costs in manufacturing. An alternative classification separates costs into: (1) direct labor, (2) material, and (3) overhead. This is often a more convenient way to analyze costs in production. The *direct labor cost* is the sum of the wages and benefits paid to the workers who operate the production equipment and perform the processing and assembly tasks. The *material cost* is the cost of all raw materials used to make the product. In the case of a stamping plant, the raw material consists of the steel sheet stock used to make stampings. For the rolling mill that made the sheet stock, the raw material is the iron ore or scrap iron out of which the sheet is rolled. In the case of an assembled product, materials include component parts manufactured by supplier firms. Thus the definition of "raw material" depends on the company. The final product of one company can be the raw material for another company. In terms of fixed and variable costs, direct labor and material must be considered as variable costs.

*Overhead costs* are all of the other expenses associated with running the manufacturing firm. Overhead divides into two categories: (1) factory overhead and (2) corporate overhead. *Factory overhead* consists of the costs of operating the factory other than direct labor and materials. Factory overhead is treated as fixed cost, although some of the items in our list could be correlated with the output level of the plant. *Corporate overhead* is the cost of running the company other than its manufacturing activities. A list of typical factory and corporate overhead expenses is presented in Table 1. Many companies operate more than one factory, and this is one of the reasons for dividing overhead into factory and corporate categories. Different factories may have significantly different factory overhead expenses.

**Table 1 Factory and Corporate Overhead expenses**

<b>Factory Overhead</b>	<b>Corporate Overhead</b>
Plant supervision	Corporate executives
Line foreman	Sales and marketing
Maintenance crew	Accounting department
Custodial services	Finance department
Security personnel	Legal counsel
Tool crib attendant	Engineering
Material handling	Research and development
Shipping and receiving	Other support personnel
Applicable taxes	Applicable taxes
Insurance	Cost of office space
Heat and air conditioning	Security personnel
Light	Heat and air conditioning
Power for machinery	Light
Factory depreciation	Insurance
Equipment depreciation	Fringe benefits
Fringe benefits	Other office costs

## 1.11 AUTOMATED FLOW LINES

An automated flow line consists of several machines or workstations which are linked together by work handling devices that transfer parts between the stations. The transfer of workparts occurs automatically and the workstations carry out their specialized functions automatically. The flow line can be symbolized as shown in Figure 1.8 using the symbols presented in Table 2. A raw workpart enters one end of the line and the processing steps are performed sequentially as the part moves from one station to the next. It is possible to incorporate buffer storage zones into the flow line, either at a single location or between every workstation. It is also possible to include inspection stations in the line to automatically perform intermediate checks on the quality of the workparts. Manual stations might also be located along the flow line to perform certain operations which are difficult or uneconomical to automate.

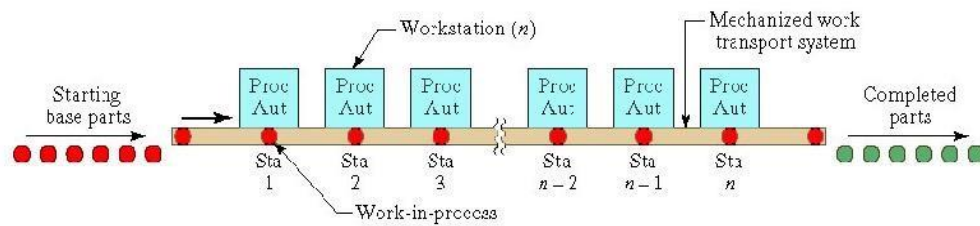

Figure 1.8 Flow line (Inline type)

SYMBOL	COMPONENT
<p>Work Head</p> <p>Machine, tooling etc.</p>	<ul style="list-style-type: none"> <li>Workstation  <u>XXXX</u>:            PROC=Processing station            ASBY=Assembly station            INSP= Inspection station            SORT= Sorting station  <u>YYY</u>:            MAN=Manual            AUT=Automated</li> </ul>
	<ul style="list-style-type: none"> <li>Material handling system (Arrow indicates workflow direction)</li> </ul>
	<ul style="list-style-type: none"> <li>Workpart            Raw workpart            Partially processed part            Finished part</li> </ul>
	<ul style="list-style-type: none"> <li>Storage buffer</li> </ul>
	<ul style="list-style-type: none"> <li>Data/Information flow</li> </ul>

Figure 1.9 Symbols used in production systems diagrams

The objectives of the use of flow line automation are, therefore:

- To reduce labor costs

- To increase production rates
- To reduce work-in-process
- To minimize distances moved between operations
- To achieve specialization of operations
- To achieve integration of operations

### 1.11.1 Configurations of automated flow line.

(1) **In-line type:** The *in-line* configuration consists of a sequence of workstations in a more or less straight line arrangement as shown in Figure 1.8. An example of an in-line transfer machine used for metalcutting operations is illustrated in Figure 1.10 and 1.11.



Figure 1.10 Example of 20 stations In-line

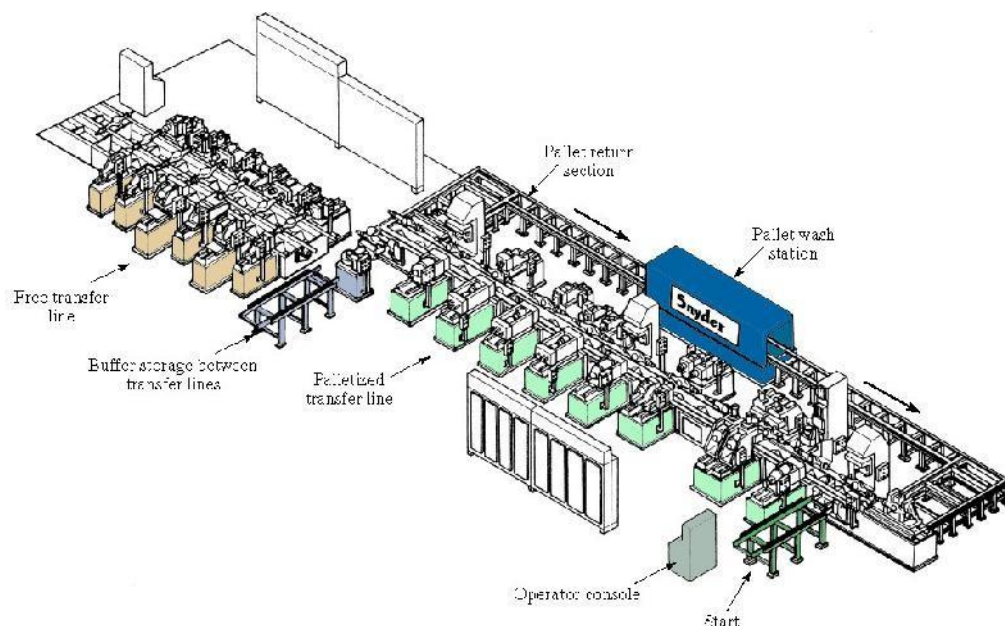

Figure 1.11 Example of 20 stations In-line configuration

**(2) Segmented In-Line Type:** The segmented *in-line* configuration consists of two or more straight line arrangement which are usually perpendicular to each other with L shaped or U shaped or rectangular shaped as shown in Figure 1.12-1.14. The flow of work can take a few 90° turns, either for workpiece reorientation, factory layout limitations, or other reasons, and still qualify as a straight-line configuration.

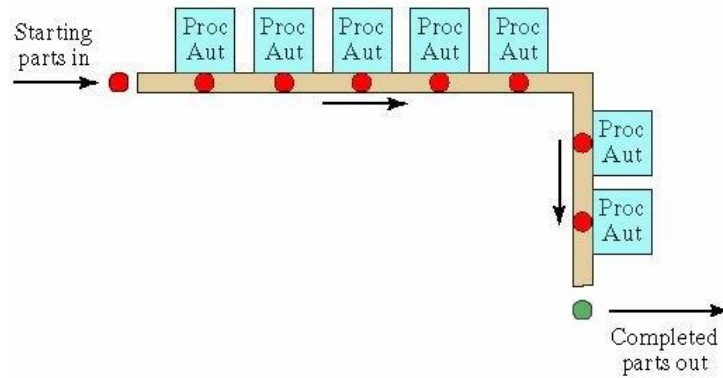

Figure 1.12 L-shaped configuration

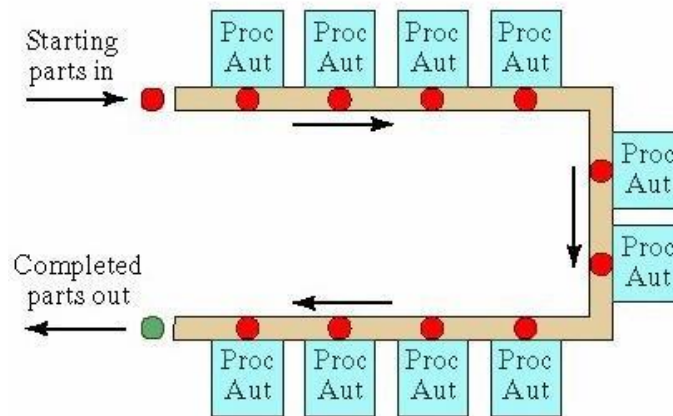

Figure 1.13 U-shaped configuration

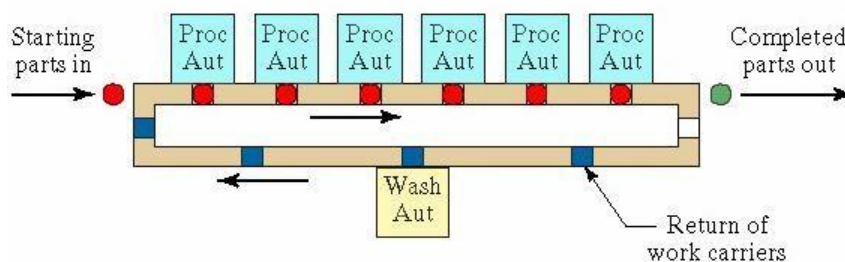

Figure 1.14 Rectangular-shaped configuration

**3) Rotary type:** In the rotary configuration, the workparts are indexed around a circular table or dial. The workstations are stationary and usually located around the outside periphery of the dial. The parts ride on the rotating table and arc registered or positioned, in turn, at each station for its processing or assembly operation. This type of equipment is often referred to as an *indexing machine* or *dial index machine* and the configuration is shown in Figure 1.15 and example of six station rotary shown in Figure 1.16.

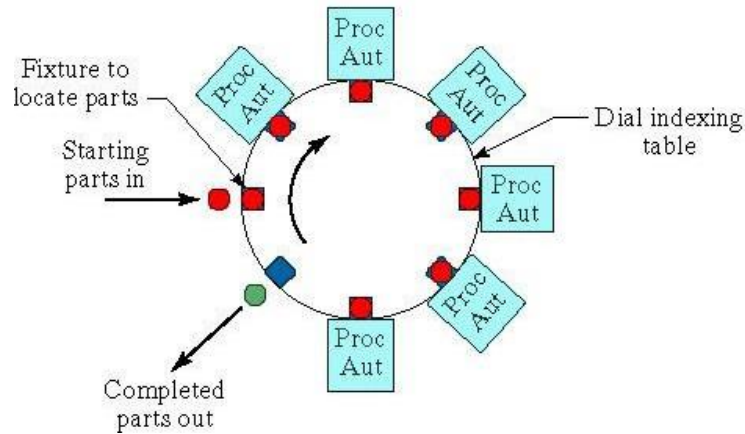

Figure 1.15 Rotary configuration



Figure 1.16 Example of 6 station rotary configuration

### 1.11.2 Methods of workpart transport

The transfer mechanism of the automated flow line must not only move the partially completed workparts or assemblies between adjacent stations, it must also orient and locate the parts in the correct position for processing at each station. The general methods of transporting workpieces on flow lines can be classified into the following three categories:

1. Continuous transfer
2. Intermittent or synchronous transfer
3. Asynchronous or power-and-free transfer

The most appropriate type of transport system for a given application depends on such factors as:

- The types of operation to be performed
- The number of stations on the line
- The weight and size of the work parts
- Whether manual stations are included on the line
- Production rate requirements
- Balancing the various process times on the line

**(1) Continuous transfer:** With the continuous method of transfer, the workparts are moved continuously at constant speed. This requires the workheads to move during processing in order to maintain continuous registration with the workpart. For some types of operations, this movement of the workheads during processing is not feasible. It would be difficult, for example, to use this type of system on a machining transfer line because of inertia problems due to the size and weight of the workheads. In other cases, continuous transfer would be very practical. Examples of its use are in beverage bottling operations, packaging, manual assembly operations where the human operator can move with the moving flow line, and relatively simple automatic assembly tasks. In some bottling operations, for instance, the bottles are transported around a continuously rotating drum. Beverage is discharged into the moving bottles by spouts located at the drum's periphery. The advantage of this application is that the liquid beverage is kept moving at a steady speed and hence there are no inertia problems.

Continuous transfer systems are relatively easy to design and fabricate and can achieve a high rate of production.

**(2) Intermittent transfer:** As the name suggests, in this method the workpieces are transported with an intermittent or discontinuous motion. The workstations are fixed in position and the parts are moved between stations and then registered at the proper locations for processing. All workparts are transported at the same time and, for this reason, the term "synchronous transfer system" is also used to describe this method of workpart transport.

**(3) Asynchronous transfer:** This system of transfer, also referred to as a "power-and-free system," allows each workpart to move to the next station when processing at the current station has been completed. Each part moves independently of other parts. Hence, some parts are being processed on the line at the same time that others are being transported between stations.

Asynchronous transfer systems offer the opportunity for greater flexibility than do the other two systems, and this flexibility can be a great advantage in certain circumstances. In-process storage of workparts can be incorporated into the asynchronous systems with relative ease. Power-and-free systems can also compensate for line balancing problems where there are significant differences in process times between stations. Parallel stations or several series stations can be used for the longer operations, and single stations can be used for the shorter operations. Therefore, the average production rates can be approximately equalized. Asynchronous lines are often used where there are one or more manually operated stations and cycle-time variations would be a problem on either the continuous or synchronous transport systems. Larger workparts can be handled on the asynchronous systems. A disadvantage of the power and free systems is that the cycle rates are generally slower than for the other types.

## **1.12 TRANSFER MECHANISMS**

There are various types of transfer mechanisms used to move parts between stations. These mechanisms can be grouped into two types: those used to provide linear travel for in-line machines, and those used to provide rotary motion for dial indexing machines.

### **1.12.1 Linear transfer mechanisms**

The commonly used linear transfer mechanisms are (a) the walking beam transfer bar system, (2) the powered roller conveyor system, and (3) the chain-drive conveyor system.

### (a) Walking beam systems

With the walking beam transfer mechanism, the work-parts are lifted up from their workstation locations by a transfer bar and moved one position ahead, to the next station. The transfer bar then lowers the pans into nests which position them more accurately for processing. For speed and accuracy, the motion of the beam is most often generated by a rotating camshaft powered by an electric motor or a roller movement in a profile powered by hydraulic cylinder. Figure 1.17 shows the working of the beam mechanism.

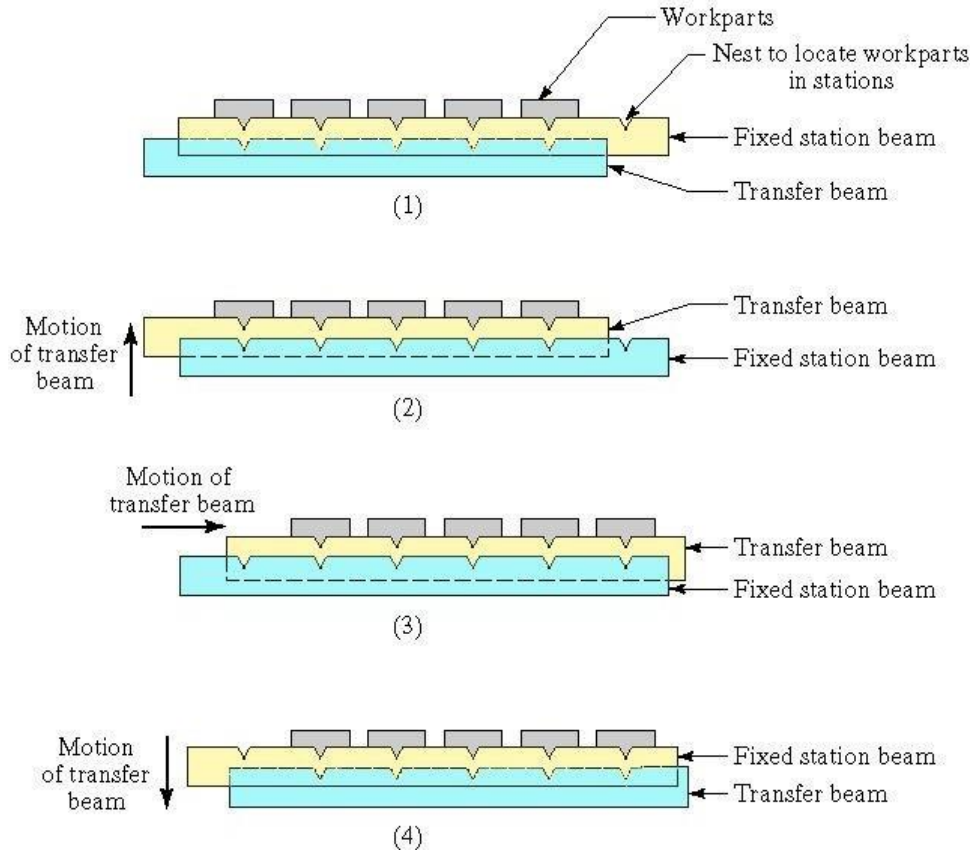

Figure 1.17 Walking beam transfer system, showing various stage during transfer stage

### (b) Powered roller conveyor system

This type of system is used in general stock handling systems as well as in automated flow lines. The conveyor can be used to move pans or pallets possessing flat riding surfaces. The rollers can be powered by either of two mechanisms. The first is a belt drive, in which a flat moving belt beneath the rollers provides the rotation of the rollers by friction. A chain drive is the second common mechanism used to power the rollers. Powered roller conveyors are versatile transfer systems because they can be used to divert work pallets into workstations or alternate tracks. This is shown in Figure 1.18.

### (c) Chain-drive conveyor system

In chain-drive conveyor system either a chain or a flexible steel belt is used to transport the work carriers. The chain is driven by pulleys in either an "over-and under" configuration, in which the pulleys turn about a horizontal axis, or an "around-the-corner" configuration, in which the pulleys rotate about a vertical axis. Figure 1.19 shows the chain conveyor transfer system.

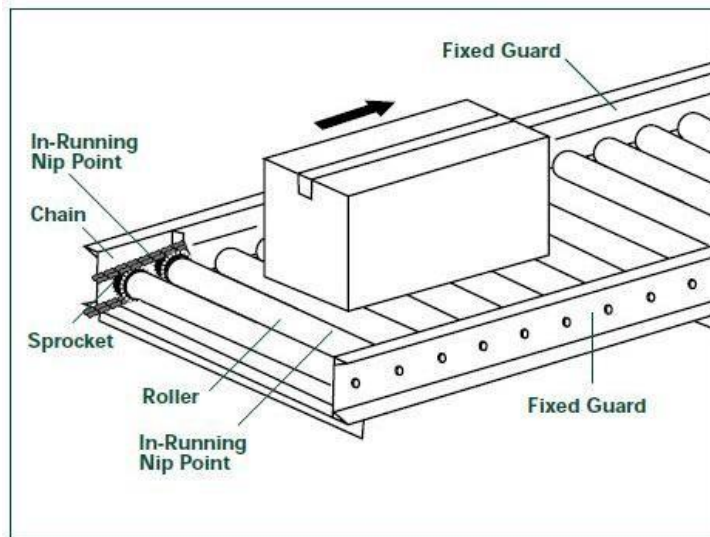

Figure 1.18 Powered roller conveyor

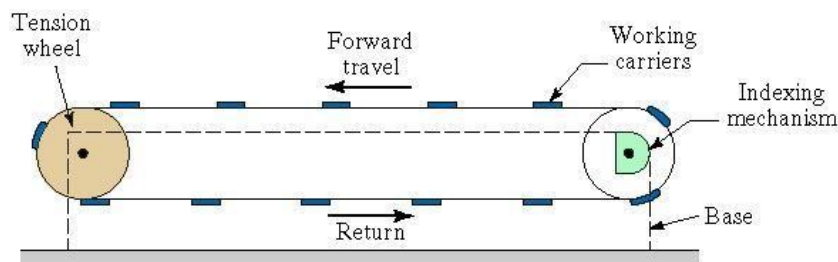

Figure 1.19 Chain drive conveyor

This general type of transfer system can be used for continuous, intermittent, or non-synchronous movement of workparts. In the non-synchronous motion, the workparts are pulled by friction or ride on an oil film along a track with the chain or belt providing the movement. It is necessary to provide some sort of final location for the workparts when they arrive at their respective stations.

### 1.12.2 Rotary transfer mechanisms

There are several methods used to index a circular table or dial at various equal angular positions corresponding to workstation locations.

#### (a) Rack and pinion

This mechanism is simple but is not considered especially suited to the high-speed operation often associated with indexing machines. The device is pictured in Figure 1.20 and uses a piston to drive the rack, which causes the pinion gear and attached indexing table to rotate. A clutch or other device is used to provide rotation in the desired direction.

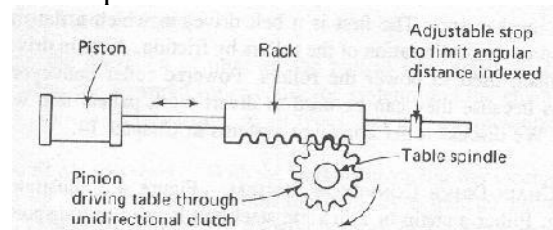

Figure 1.20 Rack and pinion mechanism



### (b) Ratchet and pawl

A ratchet is a device that allows linear or rotary motion in only one direction, while preventing motion in the opposite direction. Ratchets consist of a gearwheel and a pivoting spring loaded finger called a pawl that engages the teeth. Either the teeth, or the pawl, are slanted at an angle, so that when the teeth are moving in one direction, the pawl slides up and over each tooth in turn, with the spring forcing it back with a 'click' into the depression before the next tooth. When the teeth are moving in the other direction, the angle of the pawl causes it to catch against a tooth and stop further motion in that direction. This drive mechanism is shown in Figure 1.21.

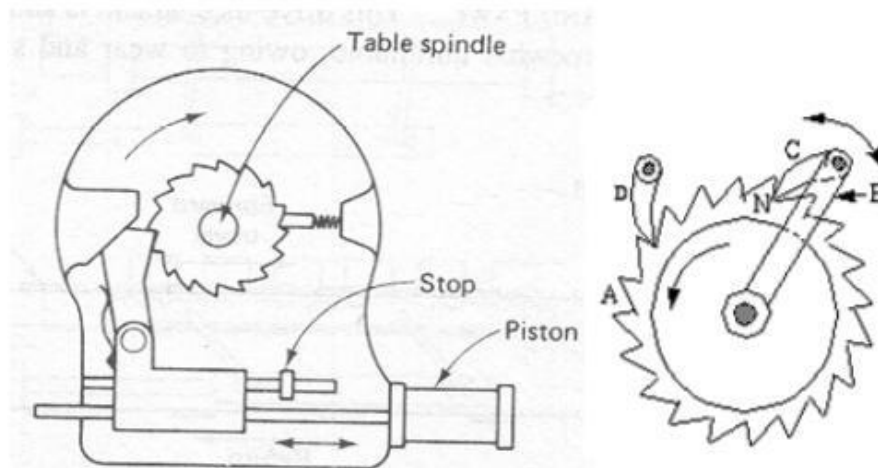

Figure 1.21 Ratchet and pawl mechanism

### (c) Geneva mechanism

The two previous mechanisms convert a linear motion into a rotational motion. The Geneva mechanism uses a continuously rotating driver to index the table, as pictured in Figure 1.22. If the driven member has six slots for a six-station dial indexing machine, each turn of the driver will cause the table to advance one-sixth of a turn. The driver only causes movement of the table through a portion of its rotation. For a six-slotted driven member,  $120^\circ$  of a complete rotation of the driver is used to index the table. The other  $240^\circ$  is dwell. For a four-slotted driven member, the ratio would be  $90^\circ$  for index and  $270^\circ$  for dwell. The usual number of indexing per revolution of the table is four, five, six, and eight.

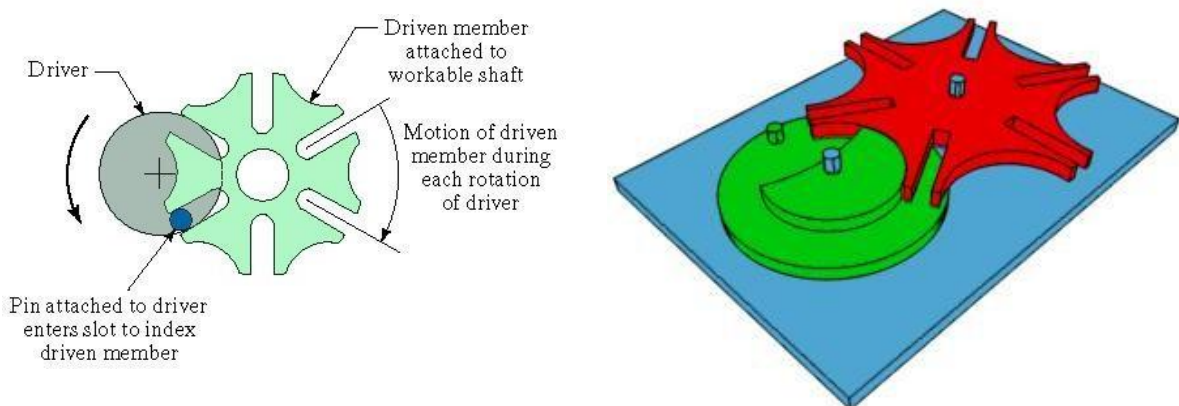

Figure 1.22 Geneva mechanism

#### (d) CAM Mechanisms

Various forms of cam mechanism, an example of which is illustrated in Figure 1.23, provide probably the most accurate and reliable method of indexing the dial. They are in widespread use in industry despite the fact that the cost is relatively high compared to alternative mechanisms. The cam can be designed to give a variety of velocity and dwell characteristics.

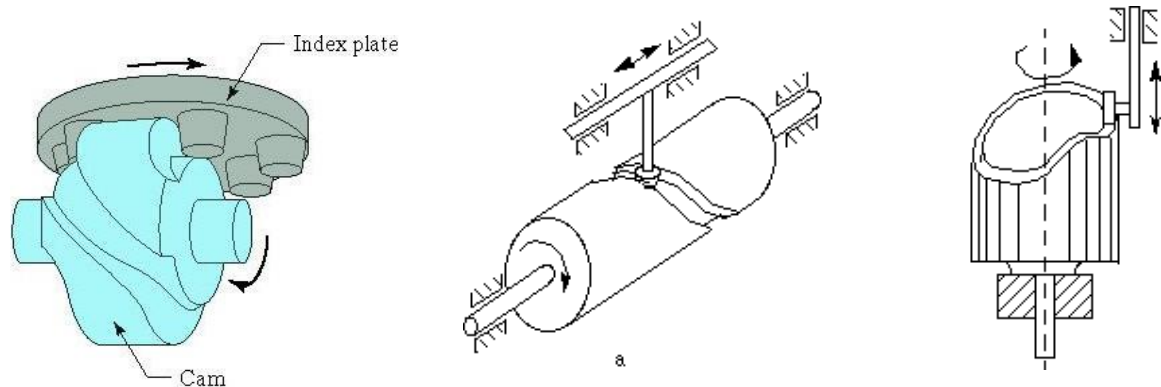

Figure 1.23 CAM mechanisms

### 1.13 CONTROL FUNCTIONS

Controlling an automated flow line is a complex problem, owing to the sheer number of sequential steps that must be carried out. There are three main functions that are utilized to control the operation of an automatic transfer system. The first of these is an operational requirement, the second is a safety requirement, and the third is dedicated to improving quality.

**1. Sequence control:** The purpose of this function is to coordinate the sequence of actions of the transfer system and its workstations. The various activities of the automated flowline must be carried out with split-second timing and accuracy. Sequence control is basic to the operation of the flow line.

**2. Safety monitoring:** This function ensures that the transfer system does not operate in an unsafe or hazardous condition. Sensing devices may be added to make certain that the cutting tool status is satisfactory to continue to process the workpart in the case of a machining-type transfer line. Other checks might include monitoring certain critical steps in the sequence control function to make sure that these steps have all been performed and in the correct order. Hydraulic or air pressures might also be checked if these are crucial to the operation of automated flow lines.

**3. Quality monitoring:** The third control function is to monitor certain quality attributes of the workpart. Its purpose is to identify and possibly reject defective workparts and assemblies. The inspection devices required to perform quality monitoring are sometimes incorporated into existing processing stations. In other cases, separate stations are included in the line for the sole purpose of inspecting the workpart.

**4. Alternative control strategies:** Conventional thinking on the control of the line has been to stop operation when a malfunction occurred. While there are certain malfunctions representing unsafe conditions that demand shutdown of the line, there are other situations where stoppage of the line is not required and perhaps not even desirable. There are alternative control strategies 1. Instantaneous control and 2. Memory control.

**(1) Instantaneous control:** This mode of control stops the operation of the flow line immediately when a malfunction is detected. It is relatively simple, inexpensive, and trouble free. Diagnostic features are often added to the system to aid in identifying the location and cause of the trouble to the operator so that repairs can be quickly made. However, stopping the machine results in loss of production from the entire line, and this is the system's biggest drawback.

**(2) Memory control:** In contrast to instantaneous control, the memory system is designed to keep the machine operating. It works to control quality and/or protect the machine by preventing subsequent stations from processing the particular workpart and by segregating the part as defective at the end of the line. The premise upon which memory-type control is based is that the failures which occur at the stations will be random and infrequent. If, however, the station failures result from cause and tend to repeat, the memory system will not improve production but, rather, degrade it. The flow line will continue to operate, with the consequence that bad parts will continue to be produced. For this reason, a counter is sometimes used so that if a failure occurs at the same station for two or three consecutive cycles, the memory logic will cause the machine to stop for repairs.

#### **1.14 BUFFER STORAGE**

Automated flow lines are often equipped with additional features beyond the basic transfer mechanisms and workstations. It is not uncommon for production flow lines to include storage zones for collecting banks of workparts along the line. One example of the use of storage zones would be two intermittent transfer systems, each without any storage capacity, linked together with a workpart inventory area. It is possible to connect three, four, or even more lines in this manner. Another example of workpart storage on flow lines is the asynchronous transfer line. With this system, it is possible to provide a bank of workparts for every station on the line.

There are two principal reasons for the use of buffer storage zones. The first is to reduce the effect of individual station breakdowns on the line operation. The continuous or intermittent transfer system acts as a single integrated machine. When breakdowns occur at the individual stations or when preventive maintenance is applied to the machine, production must be halted. In many cases, the proportion of time the line spends out of operation can be significant, perhaps reaching 50% or more. Some of the common reasons for line stoppages are:

- Tool failures or tool adjustments at individual processing stations
- Scheduled tool changes
- Defective workparts or components at assembly stations, which require that the feed mechanism be cleared
- Feed hopper needs to be replenished at an assembly station
- Limit switch or other electrical malfunction
- Mechanical failure of transfer system or workstation

When a breakdown occurs on an automated flow line, the purpose of the buffer storage zone is to allow a portion of the line to continue operating while the remaining portion is stopped and under repair. For example, assume that a 20-station line is divided into two sections and connected by a parts storage zone which automatically collects parts from the first section and feeds them to the second section. If a station jam were to cause the first section of the line to stop, the second section could continue to operate as long as the supply of parts in the

buffer zone lasts. Similarly, if the second section were to shut down, the first section could continue to operate as long as there is room in the buffer zone to store parts. Hopefully, the average production rate on the first section would be about equal to that of the second section. By dividing the line and using the storage area, the average production rate would be improved over the original 20-station Mow line. Figure 1.24 shows the Storage buffer between two stages of a production line

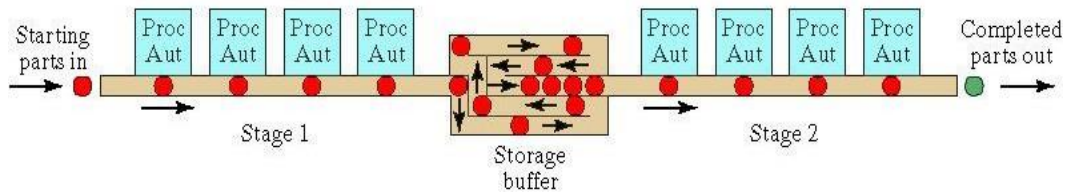

Figure 1.24 Storage buffer between two stages of a production

The reasons for using storage buffers are:

- To reduce effect of station breakdowns
- To provide a bank of parts to supply the line
- To provide a place to put the output of the line
- To allow curing time or other required delay
- To smooth cycle time variations
- To store parts between stages with different production rates

The disadvantages of buffer storage on flow lines are increased factory floor space, higher in-process inventory, more material handling equipment, and greater complexity of the overall flow line system. The benefits of buffer storage are often great enough to more than compensate for these disadvantages.

## 1.15 AUTOMATION FOR MACHINING OPERATIONS

Transfer systems have been designed to perform a great variety of different metalcutting processes. In fact, it is difficult to think of machining operations that must be excluded from the list. Typical applications include operations such as milling, boring, drilling, reaming, and tapping. However, it is also feasible to carry out operations such as turning and grinding on transfer-type systems.

There are various types of mechanized and automated machines that perform a sequence of operations simultaneously on different work parts. These include dial indexing machines, trunnion machines, and transfer lines. To consider these machines in approximately the order of increasing complexity, we begin with one that really does not belong in the list at all, the single-station machine.

### (a) Single-station machine

These mechanized production machines perform several operations on a single workpart which is fixtured in one position throughout the cycle. The operations are performed on several different surfaces by work heads located around the piece. The available space surrounding a stationary workpiece limits the number of machining heads that can be used. This limit on the number of operations is the principal disadvantage of the single-station machine. Production rates are usually low to medium. The single station machine is as shown in Figure 1.25.



Figure 1.25 single-station machines

**(b) Rotary indexing machine**

To achieve higher rates of production, the rotary indexing machine performs a sequence of machining operations on several work parts simultaneously. Parts are fixtured on a horizontal circular table or dial, and indexed between successive stations. An example of a dial indexing machine is shown in Figure 1.26.



Figure 1.26 Example of 6 station rotary configuration

**(c) Trunnion machine**

Trunnion machine is a vertical drum mounted on a horizontal axis, so it is a variation of the dial indexing machine as shown in Figure 1.27. The vertical drum is called a trunnion. Mounted on it are several fixtures which hold the work parts during processing. Trunnion machines are most suitable for small workpieces. The configuration of the machine, with a vertical rather than a horizontal indexing dial, provides the opportunity to perform operations on opposite sides of the workpart. Additional stations can be located on the outside periphery of the trunnion if it is required. The trunnion-type machine is appropriate for workparts in the medium production range.

**(d) Center column machine**

Another version of the dial indexing arrangement is the center column type, pictured in Figure 1.28. In addition to the radial machining heads located around the periphery of the horizontal table, vertical units are mounted on the center column of the machine. This increases the number of machining operations that can be performed as compared to the regular dial indexing type. The center column machine is considered to be a high-production machine which makes efficient use of floor space.

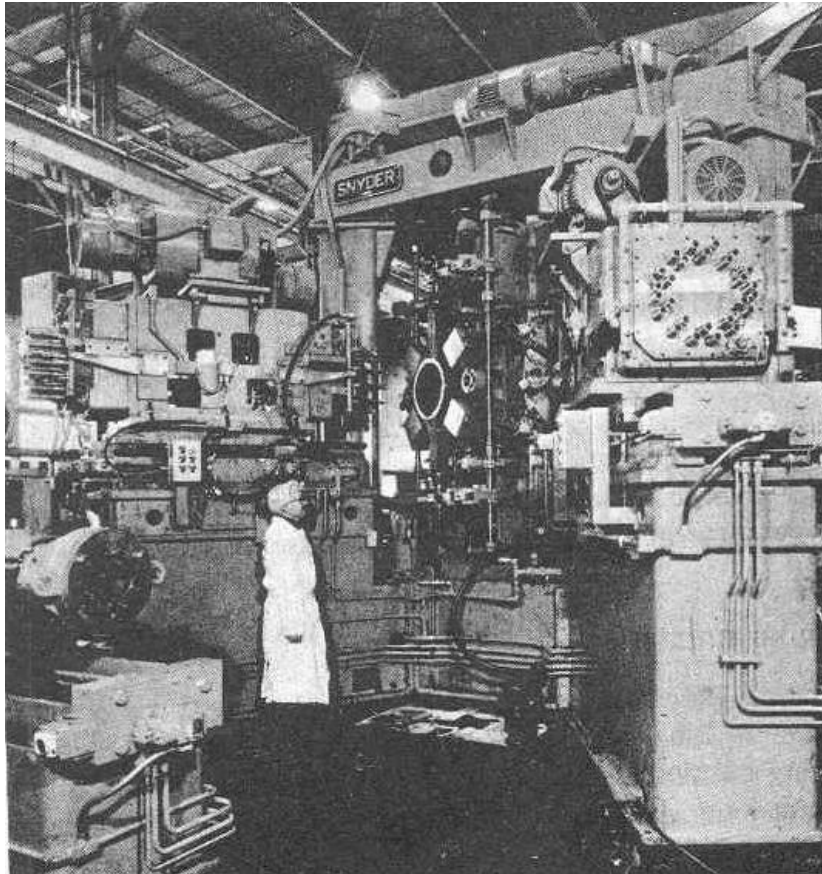

Figure 1.27 Six station trunnion machine

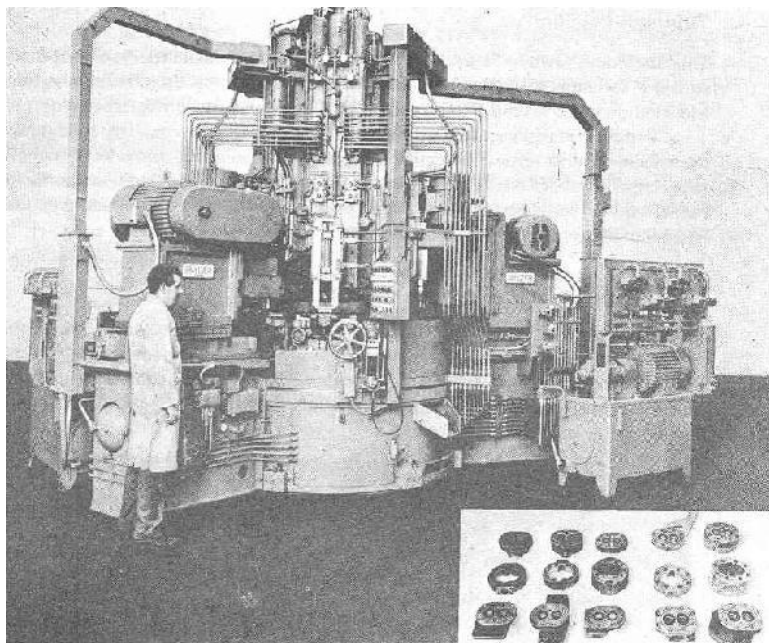

Figure 1.28 Ten-station center column machine

### (e) Transfer machine

The most highly automated and versatile of the machines is the transfer line, as explained earlier the workstations are arranged in a straight-line flow pattern and parts are transferred automatically from station to station (Figure 1.29). The transfer system can be synchronous or asynchronous, work parts can be transported with or without pallet fixtures, buffer storage can be incorporated into the line operation if desired, and a variety of different monitoring and control features can be used to manage the line. Hence, the transfer machine offers the greatest flexibility of any of the machines discussed. The transfer line can accommodate larger workpieces than the rotary-type indexing systems. Also, the number of stations, and therefore the number of operations, which can be included on the line is greater than for the circular arrangement. The transfer line has traditionally been used for machining a single product in high quantities over long production runs. More recently, transfer machines have been designed for ease of changeover to allow several different but similar workparts to be produced on the same line. These attempts to introduce flexibility into transfer line design add to the appeal of these high-production systems.



Figure 1.29 Example of 20 stations Transfer line

### 1.16 LINE BALANCING

In flow line production there are many separate and distinct processing & assembly operations to be performed on the product. Invariably, the sequence of processing or assembly steps is restricted, at least to some extent, in terms of the order in which the operations can be carried out. For example, a threaded hole must be drilled before it can be tapped. In mechanical fastening, the washer must be placed over the bolt before the nut can be turned and tightened. These restrictions are called *precedence constraints* in the language of line balancing. It is generally the case that the product must be manufactured at some specified production rate in order to satisfy demand for the product. Whether we are concerned with performing these processes & assembly operations on automatic machines or manual flow lines, it is desirable to design the line so as to satisfy all of the foregoing specifications as efficiently as possible.

The line balancing problem is to arrange the individual processing and assembly tasks at the workstations so that the total time required at each workstation is approximately the same. If the work elements can be grouped so that all the station times are exactly equal, we have

perfect balance on the line & we can expect the production to flow smoothly. In most practical situations it is very difficult to achieve perfect balance. When the workstation times are unequal, the slowest station determines the overall production rate of the line. In order to analyse line balancing problem some terminology and must be discussed.

**(a) Minimum Rational Work Element:**

In order to spread the job to be done on the line among its stations, the job must be divided into its component tasks. The minimum rational work elements are the smallest practical indivisible tasks into which the job can be divided. These work elements cannot be subdivided further. For example, the drilling of a hole would normally be considered as a minimum rational work element. In manual assembly, when two components are fastened together with a screw & nut, it would be reasonable for these activities to be taken together. Hence, this assembly task would constitute a minimum rational work element. We can symbolize the time required to carry out this minimum rational work element  $T_{ej}$  where  $j$  is used to identify the element out of the  $n$  elements that make up the total work or job.

The time  $T_{ej}$  of a work element is considered a constant rather than a variable. An automatic work head most closely fits this assumption, although the processing time could probably be altered by making adjustments in the station. In a manual operation, the time required to perform a work element will, in fact, vary from cycle to cycle.

Another assumption implicit in the use of  $T_{ej}$  values is that they are additive. The time to perform two work elements is the sum of the times of the individual elements. In practice, this might not be true. It might be that some economy of motion could be achieved by combining two work elements at one station, thus violating the additivity assumption.

**(b) Total Work Content:**

This is the aggregate of all the work elements to be done on the line. Let  $T_{wc}$  be the time required for the total work content. Hence,

$$T_{wc} = \sum_{j=1}^{n_c} T_{ej}$$

**(c) Workstation Process Time:**

A workstation is a location along the flow line where work is performed, either manually or by some automatic device. The work performed at the station consists of one or more of the individual work elements and the time required is the sum of the times of the work elements done at the station. We use  $T_{si}$  to indicate the process time at station  $i$  of an  $n$ - station line. It should be clear that the sum of the station process times should equal the sum of the work element times.

$$\sum_{i=1}^n T_{si} = \sum_{j=1}^{n_c} T_{ej}$$

**(d) Cycle Time:**

This is the ideal or theoretical cycle time of the flow line, which is the time interval between parts coming off the line. The design value of  $T_c$  would be specified according to the



required production rate to be achieved by the flow line. Allowing for downtime on the line, the value of  $T_c$  must meet the following requirement:

$$T_c \leq \frac{E}{R_p}$$

Where  $E$  is the line efficiency  $R_p$  the required production rate.

The line efficiency of an automated line will be somewhat less than 100%. For a manual line, where mechanical malfunctions are less likely the efficiency will be closer to 100%. At efficiencies less than 100%, the ideal cycle time must be reduced (or what is the same thing, the ideal production rate  $R_c$  must be increased) to compensate for the downtime.

The minimum possible value of  $T_c$  is established by the bottleneck station, the one with the largest of  $T_s$ . That is

$$T_c \geq \max T_{si}$$

If  $T_c = \max T_{si}$ , there will be idle time at all stations whose  $T_s$  values are less than  $T_c$ . Finally, since the station times are comprised of element times,

$$T_c \geq T_{ej} \text{ (for all } j, \neq \dots) n_e$$

This equation states the obvious: that the cycle time must be greater than or equal to any of the element times.

#### (e) Precedence Constraints:

These are also referred to as “technological sequencing requirements”. The order in which the work elements can be accomplished is limited at least to some extent. In the problem above, the switch must be mounted onto the motor bracket before the cover of the appliance can be attached. The right hand column in the table above gives a complete listing of the precedence constraints for assembling the hypothetical electrical appliance. In nearly every processing or assembly job, there are precedence requirements that restrict the sequence in which the job can be accomplished.

In addition to the precedence constraints described above, there may be other types of constraints on the line balancing solution. These concern the restrictions on the arrangement of the stations rather than the sequence of work elements. The first is called a *zoning constraint*. A zoning constraint may be either a positive constraint or a negative constraint. A *positive* zoning constraint means that certain work elements should be placed near each other, preferably at the same workstation. For example, all the spray painting elements should be performed together since a special semi-enclosed workstation has to be utilized. A *negative* zoning constraint indicates that work elements might interfere with one another and should therefore not be located in close proximity. As an illustration, a work element requiring fine adjustments or delicate coordination should not be located near a station characterized by loud noises and heavy vibrations.

Another constraint on the arrangement of workstations is called a *position constraint*. This would be encountered in the assembly of large products such as automobiles or major appliances. The product is too large for one worker to perform work on both sides. Therefore, for the sake of facilitating the work, operators are located on both sides of the flow line. This type of situation is referred to as a position constraint.

In the example there are no zoning constraints or position constraints given. The line balancing methods are not equipped to deal with these constraints conveniently. However, in

real-life situations, they may constitute a significant consideration in the design of the flowline.

**(f) Precedence Diagram:**

This is a graphical representation of the sequence of work elements as defined by the precedence constraints. It is customary to use nodes to symbolize the work elements, with arrows connecting the nodes to indicate the order in which the elements must be performed. Elements that must be done first appear as nodes at the left of the diagram. Then the sequence of processing and/or assembly progresses to the right. The element times are recorded above each node for convenience.

**(g) Balance Delay:**

Sometimes also called balancing loss, this is a measure of the line inefficiency which results from idle time due to imperfect allocation of work among stations. It is symbolized as  $d$  and can be computed for the flow line as follows:

$$d = \frac{nT_c - T_{wc}}{nT_c}$$

The balance delay is often expressed as a percent rather than as a decimal fraction. The balance delay should not be confused with the proportion downtime,  $D$ , of an automated flow line.  $D$  is a measure of the inefficiency that results from line stops. The balance delay measures the inefficiency from imperfect line balancing.

**1.16.1 Methods of Line Balancing (Manual)**

**(A) Largest candidate rule (LCR)**

**Procedure:**

- Step 1. List all elements in descending order of  $T_e$  value, largest  $T_e$  at the top of the list.
- Step 2. To assign elements to the first workstation, start at the top of the list and work done, selecting the first feasible element for placement at the station. A feasible element is one that satisfies the precedence requirements and does not cause the sum of the  $T_e$  value at station to exceed the cycle time  $T_c$ .
- Step 3. Repeat step 2 until no further elements can be added without exceeding  $T_c$ .

**(B) Kilbridge and Wester's Method (KWM)**

- It is a heuristic procedure which selects work elements for assignment to stations according to their position in the precedence diagram.
- This overcomes one of the difficulties with the largest candidate rule (LCR), with which elements at the end of the precedence diagram might be the first candidates to be considered, simply because their values are large.

**Procedure:**

- Step 1. Construct the precedence diagram so those nodes representing work elements of identical precedence are arranged vertically in columns.
- Step 2. List the elements in order of their columns, column I at the top of the list. If an element can be located in more than one column, list all columns by the element to show the transferability of the element.
- Step 3. Assign elements to workstations, starting with the column I elements. Continue the assignment procedure in order of column number until the cycle time is reached ( $T_c$ ).

### (C) Ranked Positional Weights Method (RPW)

- Introduced by Helgeson and Birnie in 1961.
- Combined the LCR and KWM.
- The RPW takes account of both the  $T_e$  value of the element and its position in the precedence diagram. Then, the elements are assigned to workstations in the general order of their RPW values.

#### Procedure:

- Step 1. Calculate the RPW for each element by summing the element's  $T_e$  together with the  $T_e$  values for all the elements that follow it in the arrow chain of the precedence diagram.
- Step 2 List the elements in the order of their RPW, largest RPW at the top of the list. For convenience, include the  $T_e$  value and immediate predecessors for each element.
- Step 3. Assign elements to stations according to RPW, avoiding precedence constraint and time-cycle violations.

#### EXAMPLE

A new small electrical appliance is to be assembled on a production flow line. The total job of assembling the product has been divided into minimum rational work elements. The industrial engineering department has developed time standards based on previous similar jobs. This information is given in the table below. In the right hand column are the immediate predecessors for each element as determined by precedence requirements. Assuming a cycle time of 1.0 min, find out the balance delay.

Element No.	Work element description	$T_e$ (mins)	Must be preceded by
1	Place frame on work holder and clamp	0.2	---
2	Assemble plug, grommet to power cord	0.4	---
3	Assemble brackets to frame	0.7	1
4	Wire power cord to motor	0.1	1,2
5	Wire power cord to switch	0.3	2
6	Assemble mechanism plate to bracket	0.11	3
7	Assemble blade to bracket	0.32	3
8	Assemble motor to bracket	0.6	3,4
9	Align blade and attach to motor	0.27	6,7,8
10	Assemble switch to motor bracket	0.38	5,8
11	Attach cover, inspect, and test	0.5	9,10
12	Place in tote pan for packing	0.12	11

#### SOLUTION

Construct the precedence diagram.

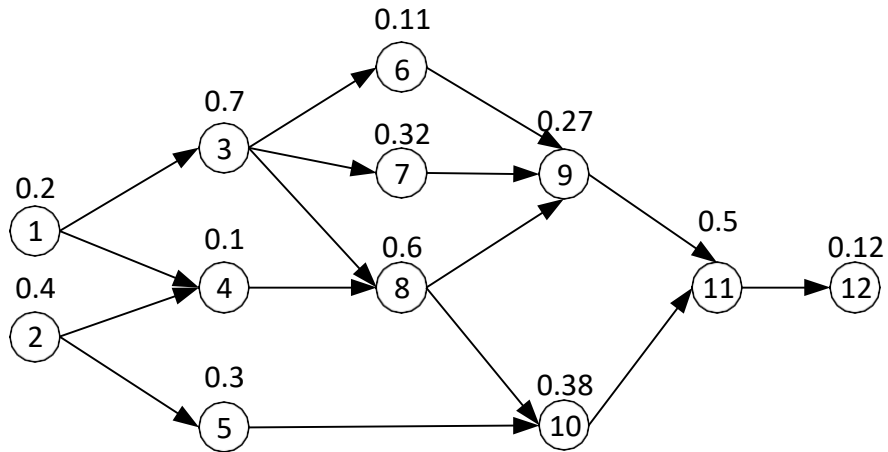

**(A) Solution by Largest Candidate Rule**

Step 1: Sorting according to the descending order of the element times.

Work element	$T_e$ (mins)	Preceded by
3	0.7	1
8	0.6	3,4
11	0.5	9,10
2	0.4	---
10	0.38	5,8
7	0.32	3
5	0.3	2
9	0.27	6,7,8
1	0.2	---
12	0.12	11
6	0.11	3
4	0.1	1,2

Step 2 & 3: Assigning work elements to workstations according to LCR

Station	Work Element	$T_e$ (min)	Station time (min)
1	2	0.4	1.0
	5	0.3	
	1	0.2	
	4	0.1	
2	3	0.7	0.81
	6	0.11	
3	8	0.6	0.98
	10	0.38	
4	7	0.32	0.59
	9	0.27	
5	11	0.50	0.62
	12	0.12	

Based on the assignment the work flow is as given below.

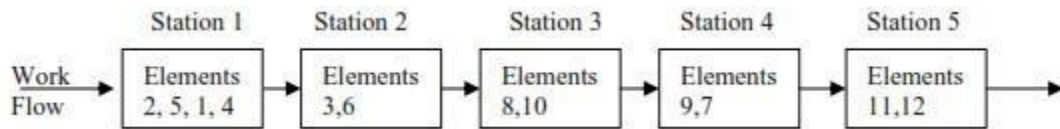

$$\text{Balance delay } d = \frac{nT_c - T_{wc}}{nT_c} = \frac{5 \times 1 - 4}{5 \times 1} = 0.2 = 20\%$$

**(B) Kilbridge and Wester's Method (KWM)**

Step 1: Constructing the precedence diagrams in terms of columns.

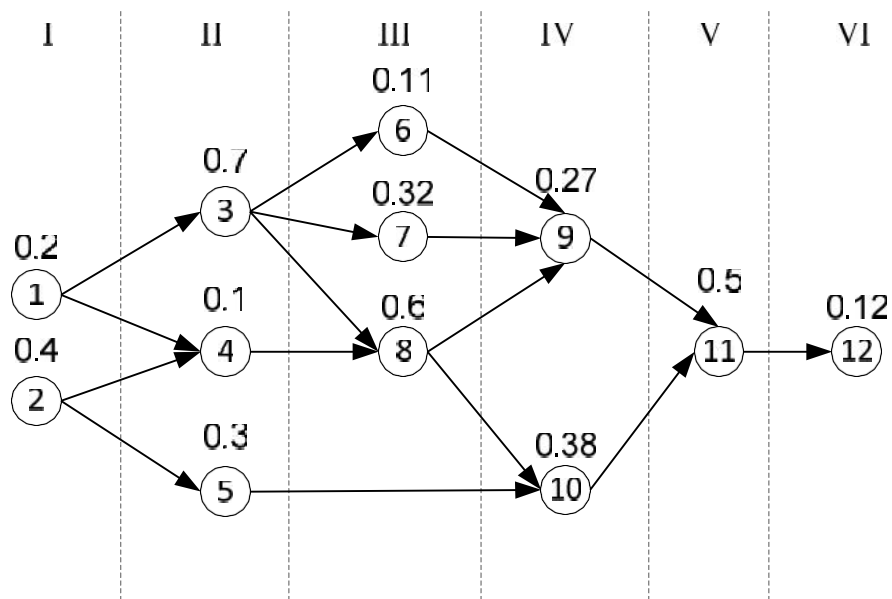

Step 2: Arranging work elements according to columns.

Work element	Column	$T_e$ (min)	Station time (min)
1	I	0.2	
2	I	0.4	0.6
3	II	0.7	
4	II	0.1	
5	II,III	0.3	1.1
6	III	0.11	
7	III	0.32	
8	III	0.6	1.03
9	IV	0.27	
10	IV	0.38	0.65
11	V	0.50	0.50
12	VI	0.12	0.12

Step 3: Assigning work elements to stations.

Station	Element	$T_e$	$\sum T_e$ at station
1	1	0.2	1.0
	2	0.4	
	4	0.1	
	5	0.3	
2	3	0.7	0.81
	6	0.11	
3	7	0.32	0.92
	8	0.6	
4	9	0.27	0.65
	10	0.38	
5	11	0.50	0.62
	12	0.12	

Since five stations are required, the balance delay is again equal to 20%, the same as provided by LCR. However, note that the work elements which make up the five stations are not the same as LCR. Also, for stations that do have the same elements, the sequence in which the elements are assigned is not necessarily identical.

In general, the KWM will provide a superior line balancing solution when compared with the LCR. However, this is also not always true as demonstrated herein.

### (C) Ranked Positional Weight Method (RPW)

Step 1: Sample calculation:

- For element 1, the elements that follow it in the arrow chain are 3, 4, 6, 7, 8, 9, 10, 11, and 12.
- The RPW for element 1 would be the sum of the  $T_e$  for all these elements, plus  $T_e$  for element 1.

Step 2: Arranging work elements according to descending RPW.

Work Element	RPW	$T_e$	Immediate predecessor
1	3.30	0.2	---
3	3.00	0.7	1
2	2.67	0.4	---
4	1.97	0.1	1,2
8	1.87	0.6	3,4
5	1.30	0.3	2
7	1.21	0.32	3
6	1.00	0.11	3
10	1.00	0.38	5,8
9	0.89	0.27	6,7,8
11	0.62	0.50	9,10
12	0.12	0.12	11

Step 3: Assigning work elements to stations.

Station	Element	$T_e$	$\sum T_e$ at station
1	1	0.2	0.9
	3	0.7	
2	2	0.4	0.91
	4	0.1	
	5	0.3	
	6	0.11	
3	8	0.6	0.92
	7	0.32	
4	10	0.38	0.65
	9	0.27	
5	11	0.50	0.62
	12	0.12	

In the RPW method, the number of stations required is five, but the maximum station process time is 0.92 minute at number 3. Accordingly the line could be operated at a cycle time of  $T_c = 0.92$  rather than 1.0 minute. Thus,

$$\text{Balance delay } d = \frac{nT_c - T_{wc}}{nT_c} = \frac{5 \times 0.92 - 4}{5 \times 0.92} = 0.13 = 13 \%$$

Increase the production rate =  $1 / 0.92 = 1.075$  units/min.

- The RPW solution represents a more efficient assignment of work elements to station than either of the two preceding solutions. However, this result is according to a cycle time different from the specified cycle time of 1 min.
- If the problem were reworked with  $T_c = 0.92$  minute using LCR or WKM, it might be possible to duplicate the efficiency provided by RPW method.

### 1.16.2 Computerized Line Balancing Methods

Computer programs have been developed based on several of the heuristic approaches for line balancing. However, the use of the computer allows a more complete enumeration of the possible solutions to a line balancing problem than is practical with a manual solution method. Accordingly, the computer line balancing algorithms are normally structured to explore a wide range of alternative allocations of elements to workstations. The computer assisted methods are:

#### COMSOAL

This acronym stands for Computer Method of Sequencing Operations for Assembly Lines. It is a method developed at Chrysler Corporation and reported by Arcus in 1966. Although it was not the first computerized line balancing program to be developed, it seems to have attracted considerably more attention than those which preceded it. The procedure is to iterate through a sequence of alternative solutions and keep the best one. The basic algorithm of COMSOAL is;

- Step 1. Construct list A, showing all work elements in one column and the total number of elements that immediately precede each element in an adjacent column. This is illustrated in Table 1. Note that these types of data would be quite easy to compile and manipulate by the computer.

- Step 2. Construct list B (Table 2), showing all elements from list A that have no immediate predecessors.
- Step 3. Select at random one of the elements from list B. The computer would be programmed to perform this random selection process. The only constraint is that the element selected must not cause the cycle time  $T_c$  to be exceeded.
- Step 4. Eliminate the element selected in step 3 from lists A and B and update both lists if necessary. Updating may be needed because the selected element was probably an immediate predecessor for some other element(s). Hence, there may be changes in the number of immediate predecessors for certain elements in list A; and there may now be some new elements having no immediate predecessors that should be added to list B. To illustrate, suppose in step 3 that element 1 is chosen at random for entry into the first workstation. This would mean that element 3 no longer has any immediate predecessors. Tables 3 and 4 show the updated lists A and B, respectively.
- Step 5. Again select one of the elements from list B which is feasible for cycle time.
- Step 6. Repeat steps 4 and 5 until all elements have been allocated to stations within the  $T_c$  constraint. One possible solution to the problem is shown in Table 5. The balance delay is again  $d = 20\%$ , the same efficiency as obtained with the largest candidate rule and the Kilbridge and Wester method.
- Step 7. Retain the current solution and repeat steps 1 through 6 to attempt to determine an improved solution. If an improved solution is obtained, it should be retained.

Table 1 List A in COMSOAL at the beginning of the Sample Problem

Work Element	Number of Immediate predecessor
1	0
2	0
3	1
4	2
5	1
6	1
7	1
8	2
9	3
10	2
11	2
12	1

Table 2 List B in COMSOAL at the beginning of the Sample Problem

Elements with no immediate predecessor
1
1



Table 3 List A in COMSOAL after Step 3

Work Element	Number of Immediate predecessor
2	0
3	0
4	1
5	1
6	1
7	1
8	2
9	3
10	2
11	2
12	1

Table 4 List B in COMSOAL after Step 3

Elements with no immediate predecessor
2
3

Table 5 Possible solution with COMSOAL

Station	Element	$T_e$	$\sum T_e$ at station
1	1	0.2	1.0
	2	0.4	
	5	0.3	
	4	0.1	
2	3	0.7	0.81
	6	0.11	
3	8	0.6	0.98
	10	0.38	
4	7	0.32	0.59
	9	0.27	
5	11	0.50	0.62
	12	0.12	

The steps involved in the COMSOAL algorithm represent an uncomplicated data manipulation procedure. It is therefore ideally suited to computer programming with large set of work elements. Although there is much iteration in the algorithm, this is of minor consequence because of the speed with which the computer is capable of performing the iterations.

### CALB

In 1968 the Advanced Manufacturing Methods Program (AMM) of the IIT Research Institute introduced a computer package called CALB (for Computer Assembly Line Balancing or Computer-Aided Line Balancing). Its applications have included a variety of assembled products, including automobiles and trucks, electronic equipment, appliances, military hardware, and others. CALB can be used for both single-model and mixed-model lines. For

the single-model case, the data required to use the program include the identification of each work element  $T_e$  for each element, the predecessors, and other constraints that may apply to the line. Also needed to balance the line is information on minimum and maximum allowable time per workstation (in other words, cycle time data). The CALB program starts by sorting the elements according to their  $T_e$  and precedence requirements. Based on this sort, elements are assigned to stations so as to satisfy the minimum and maximum allowable station times. To use CALB on mixed model lines, additional data are required such as the production requirements per shift for each model to be run on the line, and a definition of relative elements usage per model.

### **ALPACA**

This computer system was developed by General Motors in 1967. The acronym represents “Assembly Line Planning and Control Activity.” ALPACA is described as an interactive line balancing system in which the user can transfer work from one station to another along the flow line and immediately assess the relative efficiency of the change. ALPACA was designed to cope with the complications due to product changeover on the assembly line. The system user can quickly determine what changes in work element assignments should be made to maintain a reasonable line balance for the ever changing product flow.

#### **1.16.3 Other ways to improve the Line Balance**

1. *Dividing work elements*: The minimum rational work element is to be judiciously determined. In some cases although a work element can be further divided, still it can be taken as minimum rational work element to avoid bottleneck situation.
2. *Changing workhead speeds at automatic stations*: Through a process increasing the speed/feed combinations at the stations with long process time, and reducing the speed/feed combinations at stations with idle time, it should be possible to improve the balance on the flow line. This would tend to reduce the frequency of downtime occurrences on the line.
3. *Method analysis* The study of human work activity may result in better workplace layout, redesigned tooling and fixturing or improved hand and body motions.
4. *Pre-assembly of components*: Reduce the total amount of work done on the regular assembly line by another assembly cell or by outsourcing. The reasons may be (a) required process may be difficult to implement on the regular assembly line, (b) variations in process times (adjustments or fitting) may result in a longer cycle time, and (c) an assembly cell setup in the plant or a vendor with certain special capabilities to perform the work may be able to achieve higher quality.
5. *Inventory buffers between stations*: Storage buffers may be in use to take care of the cycle time variation due to human activity which is characterized by random variations.
6. *Parallel stations*: These may be used to avoid bottleneck situation due to sequential nature of line.

### **1.17 FLEXIBLE MANUAL ASSEMBLY LINES**

The well defined pace of a manual assembly line has merit from the point of view of maximizing production rate. However, the workers on the assembly line often feel as if they are being driven too hard. Frequent complaints by the workers, poor-quality workmanship, sabotage of the line equipment, and other problems have occurred on high-production flow lines. To relieve some of these conditions, a new concept in assembly lines has developed in which the pace of the work is controlled largely by the workers at the individual stations rather than by a powered conveyor moving at a fixed speed.

The new concept was pioneered by Volvo in Sweden. It relies on the use of independently operated work carriers that hold major components and/or sub assemblies of the automobile and deliver them to the manual assembly workstations along the line. The work carriers in the system are called automated guided vehicles (AGVs), and they are designed to follow guide paths in the factory which are routed to the various stations. The independently operating work carriers allow the assembly system to be configured with parallel paths, queues of parts between stations, and other features not typically found on a conventional in-line assembly system. In addition, these manual assembly lines can be designed to be highly flexible, capable of dealing with variations in product and corresponding variations in assembly cycle times at the different work-stations.

The type of flexible assembly system described here is generally used when there are many different models to be produced, and the variations in the models result in significant differences in the work content times involved. The work cycle time at any given station might range between 4 and 10 min, depending on model type. Production throughput is determined by the number of similar stations in parallel. A provisioning station is often used before the bank of parallel assembly stations to load the work carrier with the components that will be needed. This permits flexibility in the routing of the carriers to the different stations. Hardware items common to all models are usually stocked at the workstations. The typical operation of the system allows for time variations at a given station resulting from worker skill and effort and from model differences. Instead of the sub assembly moving forward at a fixed rate as in a conventional flow line, the worker takes the time needed to accomplish the work elements required for the particular model currently being processed. When the work is completed, the work carrier is released by the worker to proceed toward the next assembly operation.

Benefits of this flexible assembly system compared to the conventional assembly line include greater worker satisfaction, better-quality product, increased capability to accommodate model variations, and greater ability to cope with problems that require more time rather than stopping the entire production line.

### **1.18 AUTOMATED ASSEMBLY SYSTEMS**

Automated assembly refers to the use of mechanized and automated devices to perform the various functions in an assembly line or cell. Automated assembly system performs a sequence of automated operations to combine multiple components in to a single entity which can be a final product or sub assembly. Automated assembly technology should be considered under the following conditions.

- ✓ High product demand
- ✓ Stable product design
- ✓ The assembly consists of no more than a limited number of components.
- ✓ The product is designed for automated assembly.

Automated assembly system involves less investment compared to transfer lines because

1. Work part produced are smaller in size compared to transfer lines.
2. Assembly operations do not have the large mechanical forces and power requirement.
3. Size is very less compared to transfer lines.

The following recommendations and principles can be applied in product design to facilitate automated assembly

- ***Reduce the amount of assembly required:*** This principle can be realized during design by combining functions within the same part that were previously accomplished by separate components in the product. The use of plastic molded parts to substitute for sheet metal parts is an example of this principle. A more complex geometry molded into a plastic part might replace several metal parts. Although the plastic part may seem to be more costly, the savings in assembly time probably justify the substitution in many cases.
- ***Use modular design:*** In automated assembly, increasing the number of separate assembly steps that are done by a single automated system will result in an increase in the downtime of the system. To reduce this effect, it can be suggested that the design of the product be modular, with perhaps each module requiring a maximum of 12 or 13 parts to be assembled on a single assembly system. Also, the sub assembly should be designed around a base part to which other components are added.
- ***Reduce the number of fasteners required:*** Instead of using separate screws and nuts, and similar fasteners, design the fastening mechanism into the component design using snap fits and similar features. Also, design the product modules so that several components are fastened simultaneously rather than each component fastened separately.
- ***Reduce the need for multiple components to lie handled at once:*** The preferred practice in automated assembly machine design is to separate the operations at different stations rather than to handle and fasten multiple components simultaneously at the same workstation. (It should be noted that robotic technology is causing a rethinking of this practice since robots can be programmed to perform more complex assembly tasks than a single station in a mechanized assembly system.)
- ***Limit the required directions of access:*** This principle simply means that the numbers of directions in which new components are added to the existing subassembly should be minimized. If all of the components can be added vertically from above, this is the ideal situation. Obviously, the design of the subassembly module determines this.
- ***Require high quality in components:*** High performance of the automated assembly system requires consistently good quality of the components that are added at each workstation. Poor-quality components cause jams in the feeding and assembly mechanisms which cause downtime in the automated system.
- ***Implement hopperability:*** This is a term that is used to identify the ease with which a given component can be fed and oriented reliably for delivery from the parts hopper to the assembly workhead.

### 1.18.1 Types of automated assembly systems

Based on the type of work transfer system that is used in the assembly system:

- Continuous transfer system

- Synchronous transfer system
- Asynchronous transfer system
- Stationary base part system

The first three types involve the same methods of workpart transport described in automated flow line. In the stationary base part system, the base part to which the other components are added is placed in a fixed location, where it remains during the assembly work.

Based on physical configuration:

- Dial-type assembly machine
- In-line assembly machine
- Carousel assembly system
- Single-station assembly machine

The *dial-type machine*, the base parts are indexed around a circular table or dial. The workstations are stationary and usually located around the outside periphery of the dial. The parts ride on the rotating table and are registered or positioned, in turn, at each station a new component is added to base part. This type of equipment is often referred to as an *indexing machine* or *dial index machine* and the configuration is shown in Figure 1.30.

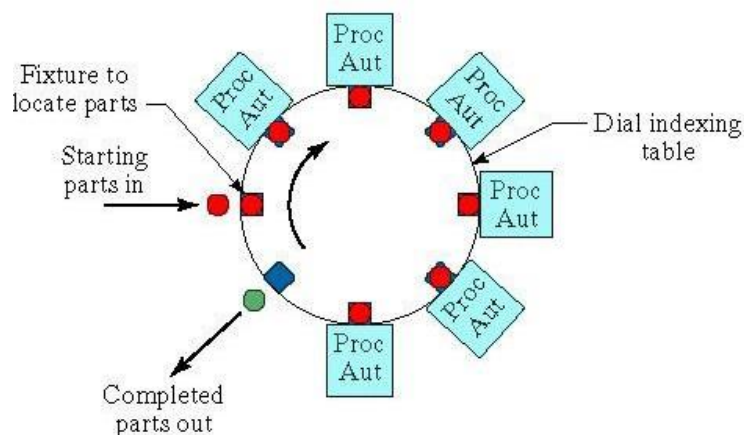

Figure 1.30 Dial type assembly machine

The *in-line* configuration assembly system consists of a sequence of workstations in a more or less straight line arrangement as shown in Figure 1.31. The *in-line assembly machine* consists of a series of automatic workstations located along an in-line transfer system. It is the automated version of the manual assembly line. Continuous, synchronous, or asynchronous transfer systems can be used with the in-line configuration.

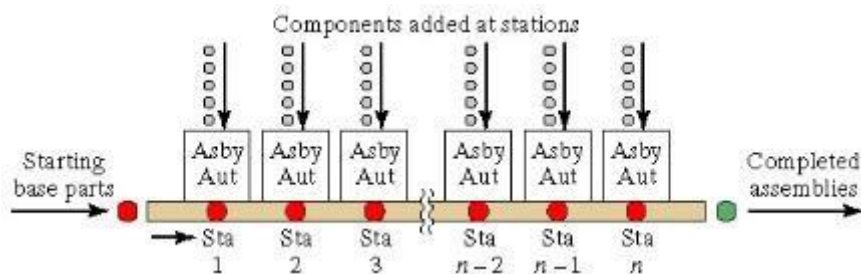

Figure 1.31 In-line type assembly machine

The *segmented in-line* configuration consists of two or more straight-line arrangement which are usually perpendicular to each other with L-Shaped or U-shaped or rectangular shaped as shown in Figure 1.32-1.34. The flow of work can take a few 90° turns, either for workpieces reorientation, factory layout limitations, or other reasons, and still qualify as a straight line configuration.

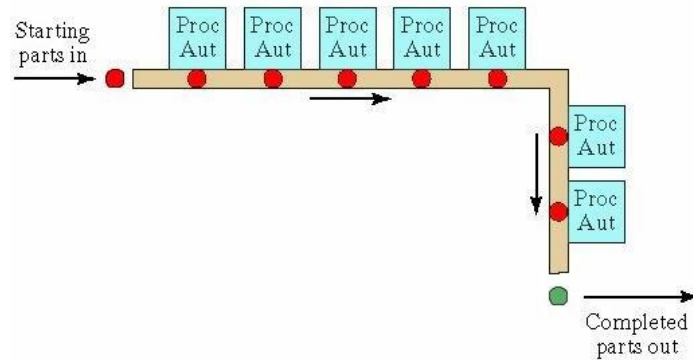

Figure 1.32 L-shaped configuration

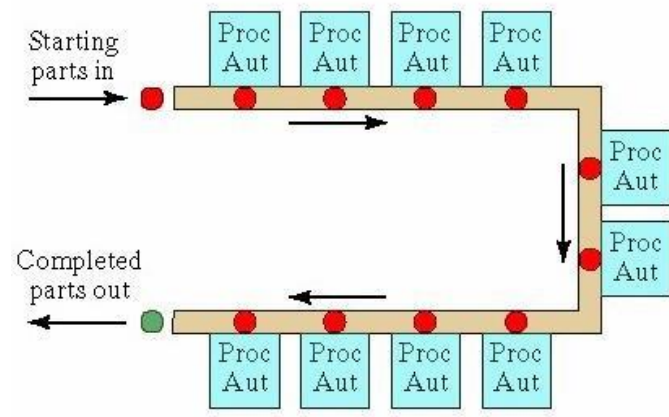

Figure 1.33 U-shaped configuration

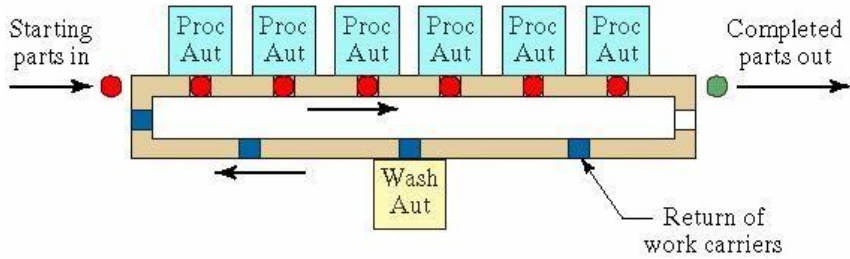

Figure 1.34 Rectangular-shaped configuration

*Carousel assembly system* represents a hybrid between the circular flow of work provided by the dial assembly machine and straight work flow of the in-line as shown in the Figure 1.35. Carousels can be operated with continuous, synchronous, asynchronous transfer mechanisms.

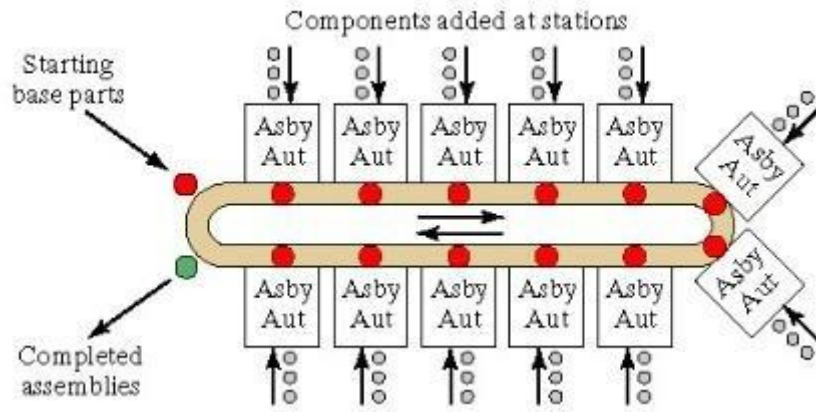

Figure 1.35 Carousel assembly system

In the *single-station assembly machine*, the assembly operations are performed at a single location (stationary base part system) as shown in Figure 1.36. The typical operation involves the placement of the base part at the workstation where various components are added to the base. The components are delivered to the station by feeding mechanisms, and one or more workheads perform the various assembly and fastening operations.

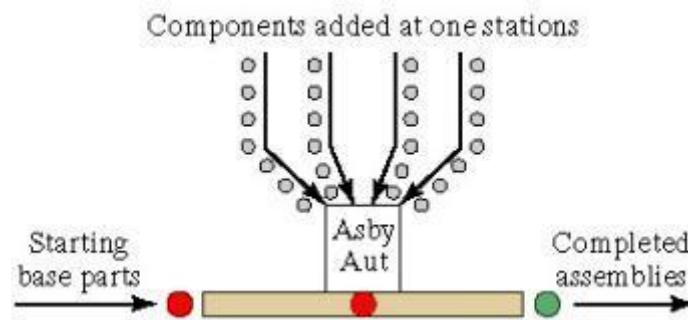

Figure 1.36 Single station assembly machine

### 1.18.2 Part feeding devices

In each of the configurations described above, a means of delivering the components to the assembly workhead must be designed. The hardware system that delivers components to the workhead in an automated assembly system typically consists of the following elements as shown in Figure 1.37. Parts delivery to workstations depends upon specific pieces of delivery equipment, particularly associated with automatic assembly. These pieces of equipment are connected together to create the parts delivery system. The hardware for parts delivery consists of:

- **Hopper:** This is the container into which the components are loaded at the workstation. A separate hopper is used for each component type. The components are usually loaded into the hopper in bulk. This means that the parts are randomly oriented initially in the hopper.
- **Parts feeder:** This is a mechanism that removes the components from the hopper one at a time for delivery to the assembly workhead. The hopper and parts feeder are often combined into one operating mechanism. The vibratory bowl feeder, pictured in Figure 1.38, is a very common example of the hopper-feeder combination.

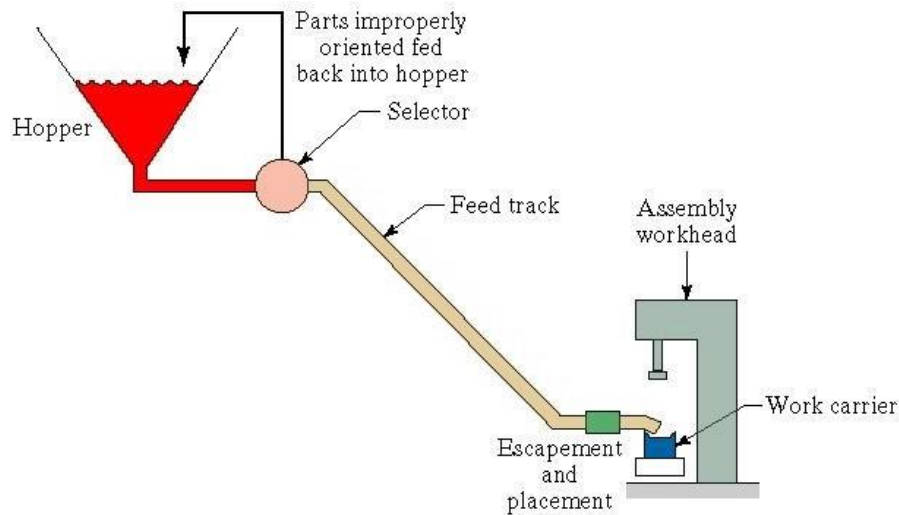

Figure 1.37 Elements of part delivery system

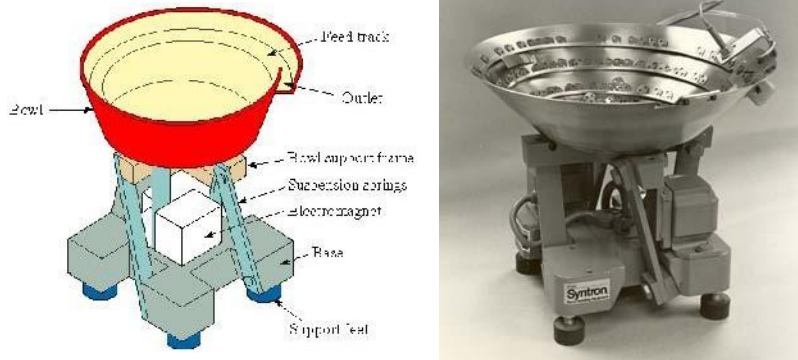

Figure 1.38 Vibratory bowl feeder

- Selector and/or orientor:** These elements of the delivery system establish the proper orientation of the components for the assembly workhead. A selector is a device that acts as a filter, permitting only parts that are in the correct orientation to pass through. Components that are not properly oriented are rejected back into the hopper. An orientor is a device that allows properly oriented parts to pass through but provides a reorientation of components that are not properly oriented initially. Several selector and orientor schemes are illustrated in Figure 1.39. Selector and orientor devices are often combined and incorporated into one hopper-feeder system.
- Feed track:** The preceding elements of the delivery system are usually located some distance from the assembly workhead. A feed track is used to transfer the components from the hopper and parts feeder to the location of the assembly workhead, maintaining proper orientation of the parts during the transfer. There are two general categories of feed tracks: gravity and powered. The gravity feed track is most common. In this type the hopper and parts feeder are located at an elevation that is above the elevation of the workhead. The force of gravity is used to deliver the components to the workhead. The powered feed track uses vibratory action, air



pressure, or other means to force the parts to travel along the feed track toward the assembly workhead.

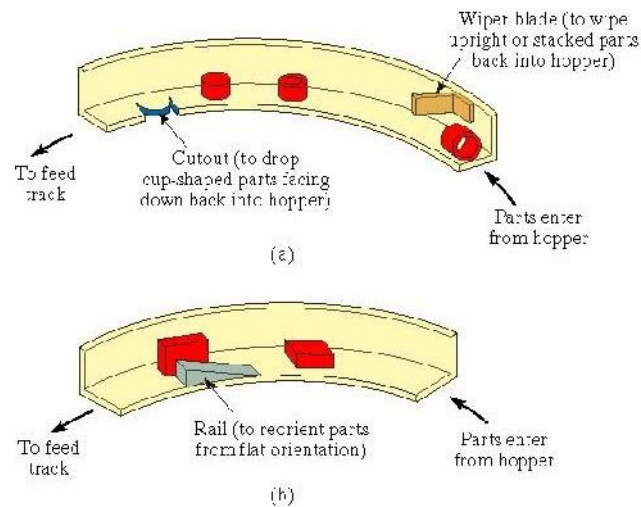

Figure 1.39 (a) Selector and (b) orientor devices used upon the feed track

- **Escapement and placement device:** The purpose of the escapement device is to remove components from the feed track at time intervals that are consistent with the cycle time of the assembly workhead. The placement device physically places the component in the correct location at the workstation for the assembly operation by the workhead. Several types of escapement and placement devices are shown in Figure 1.40.
  - Horizontal placement device: Device used on dial-type assembly machines: parts move via horizontal delivery into vacant nests on the dial, as they appear, from the feed track; meanwhile the circular motion of the dial table means that the nests are revolved away from the feed track, permitting the next component in the feed track to move into the next vacant nest, and so forth.
  - Vertical placement device: Device used on dial-type assembly machines: here, the parts feeder is arranged vertically above the dial table, so that when the table turns, to reveal an empty nest, the component can fall by gravity from the feed track into the empty nest. Successive parts fall by gravity to take up their position at the mouth of the feed track in turn.
  - Escapement device: This device is actuated by the top of the carrier contacting the lower surface of the rivet-shaped part, causing its upper surface to press against the spring blade, which releases the part so that it falls into the work carrier nest. The work carriers are moved horizontally to cause the release of the part. After the first part has escaped the work carrier released part moves off and to be replaced by the next work carrier, and so forth.
  - Pick-and-place mechanism: This mechanism uses a pick-and-place unit with a revolving arm, so that parts may be removed from the feed track, and placed into work carriers.

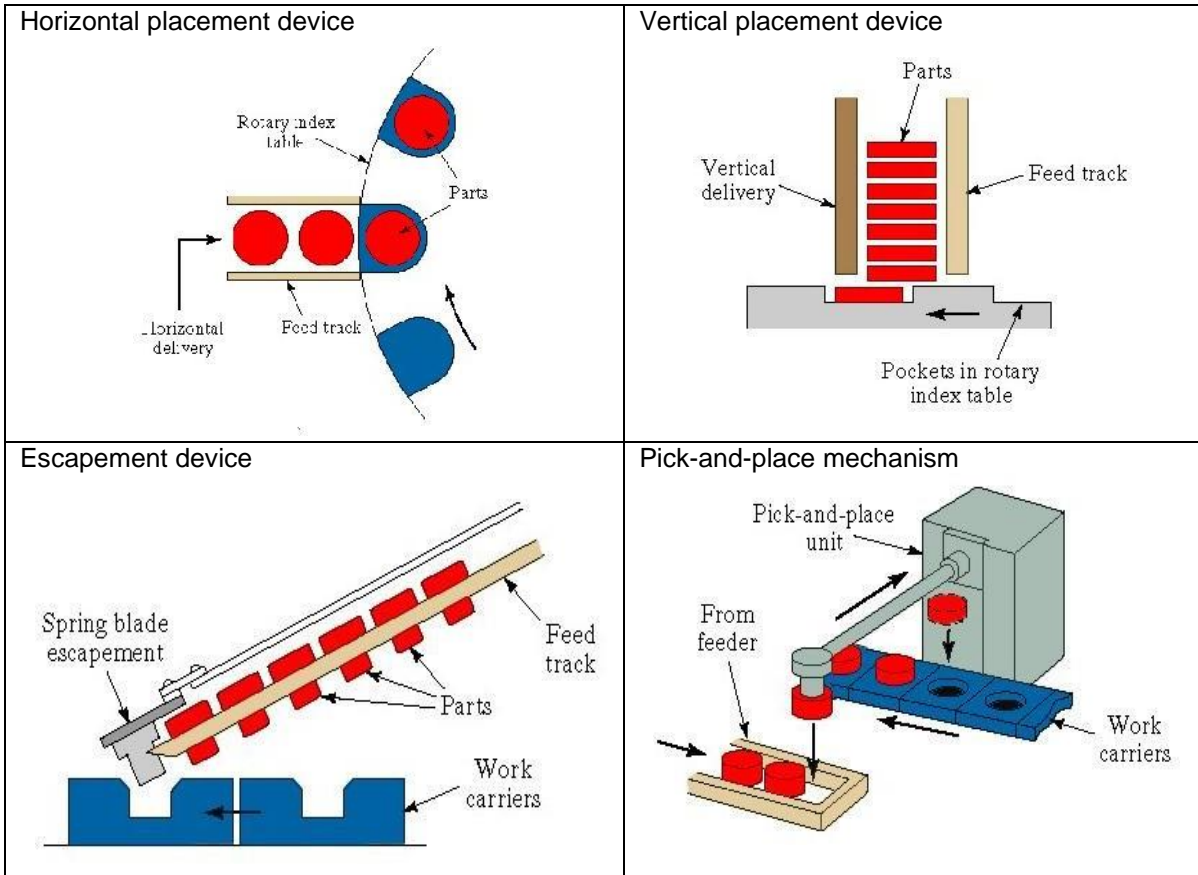

Figure 1.39 Escapement and placement devices

**2.0 OVERVIEW OF CAD**

Computer aided design (CAD) can be defined as the use of computer systems to assist in the creation, modification, analysis or optimization of a design. The computer systems consist of the hardware and software to perform the specialized design functions required by the user. Modern CAD systems are based on interactive computer graphics (ICG). Interactive computer graphics denotes a user-oriented system in which the computer is employed to create, transform and display data in the form of pictures or symbols.

The hardware of the ICG system includes a central processing unit, one or more workstations (including the graphics display terminals) and peripheral devices such as printers, plotters and drafting equipment. The software consists of the computer programs needed to implement graphics processing on the system. The software would also typically include additional specialized application programs to accomplish a particular engineering functions required by the user. The ICG system is one component of a computer aided design system. The other major ICG component is the human designer. Interactive computer graphics is a tool used by the designer to solve a design problem, In effect, the ICG system magnifies the powers of the designer. This has been referred to as the synergistic effect. The designer performs the portion of the design process that is most suitable to human intellectual skills, the computer performs the task best suited to its capabilities and the resulting system exceeds the sum of its components.

**2.1 REASONS FOR IMPLEMENTING CAD**

1. *To increase the productivity of the designer:* CAD helps the designer to visualize the product and its component sub-assemblies and parts. This reduces the time required to synthesize, analyze and document the design. This productivity improvement results not only into lower design cost but also into shorter design project completion times.
2. *To improve the quality of design:* A CAD system permits a thorough engineering analysis within a short time using various software and a larger number of design alternatives can be investigated. Design errors are also reduced by the accuracy built into the system by means of calculations and checks available with the system. These factors lead to improvement in the quality and accuracy in the design.
3. *To improve communications through documentation:* The use of CAD system provides better engineering drawings, more standardization in the drawings, better documentation of the design, fewer drawing errors and greater legibility for the drawing.
4. *To create a database for manufacturing:* to the process of creating the documentation for the product design (geometry and dimension of components, bill of materials, etc.) much of the required database to manufacture is also created which can be applied for several computer integrated manufacturing (CIM) applications like CNC programming, programming of robots, process planning and so on.

**2.2 THE DESIGN PROCESS**

Design is the act of devising an original solution to a problem by a combination of principles, resources and products in design. Design process is the pattern of activities that is followed by the designer in arriving at the solution of a technological problem. A preliminary design is made based on the available information and is improved upon as more and more information is generated. The process of design is segmented into six stages as shown in Figure 2.1. The design process is repetitive as well as creative. The repetitive tasks can be

performed by computers; however, the creative tasks (stages 1 and 2) are always done only on the efforts of human being.

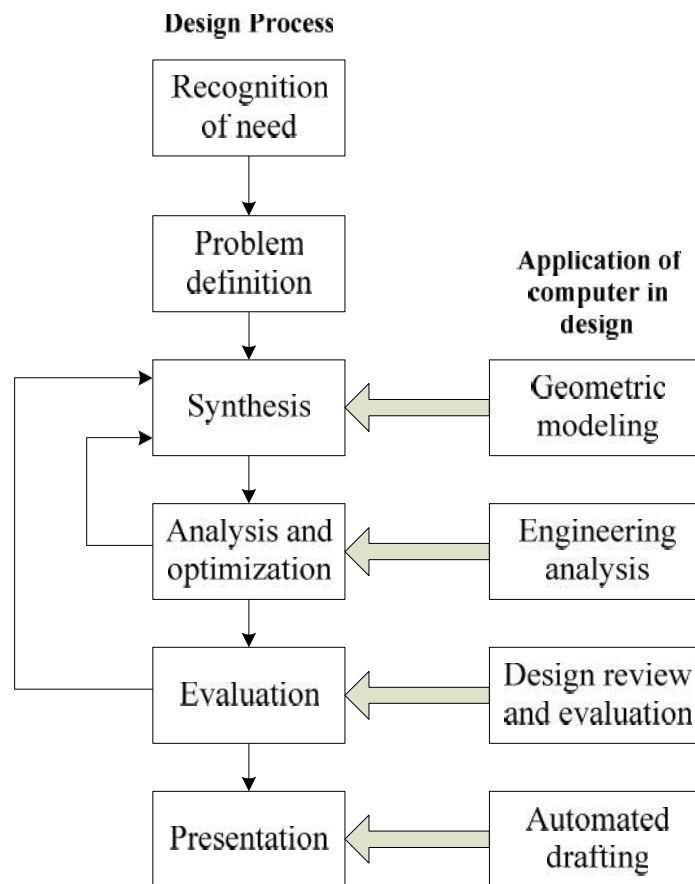

Figure 2.1 CAD modified design process

- Stage 1 :** *Recognition of need.* Recognizing the fact that there is a need for a new product for intended function. It may also include the modification in the existing product.
- Stage 2 :** *Problem definition.* Problem is fully defined in terms of functionality and meeting other requirements such as ergonomic; performance-data, statutory, etc. Thus full specifications of product can be yielded. [Crude representation of idea.]
- Stage 3 :** *Synthesis.* The design undergoes synthesis, joining its various elements.
- Stage 4 :** *Analysis and optimization.* Product analysis reveals the weaknesses and thus weaknesses can be considered for improvement. This process is repeated until an acceptable design achieved.
- Stage 5 :** *Evaluation.* The optimized design is reviewed from the point of view of expected performance. It can be done through prototype modeling and against the set standard.
- Stage 6 :** *Presentation.* Stages 4 and 5 are repeated until acceptable, optimized design is achieved. These stages are basically iterative in nature. Iteration depends on the creativeness, ingenuity (skill for devising) and experience of designers and the software (tools) available. The process (stage 1 and 2) are human dependent while the stages 3, 4, 5 and 6 (four stages) are computer based (CAD).

## Application of computers in design

Engineering design has traditionally been accomplished on drawing boards with the design being documented in the form of a detailed engineering drawing. This process is iterative in nature and is time consuming. The computer can beneficially be used in the design process in CAD. The design task is performed by a CAD system rather than a single designer working over a drawing board. The various design related tasks, which are performed by the CAD system, can be grouped into four functional areas (Figure 2.1):

1. Geometric modeling
2. Engineering analysis
3. Design review and evaluation
4. Automated drafting

### 1. Geometric Modeling

Geometric modeling is concerned with the computer compatible mathematical description of the geometry of an object. The mathematical description allows the image of the object to be displayed and manipulated on a graphics terminal through signals from the CPU of the CAD system. The software that provides geometric modeling capabilities must be designed for efficient use both by the computer and the human designer.

There are different methods of representing the object in geometric modeling. The basic form uses wire frames to represent the object. In this form, the object is displayed by interconnected lines. Geometric modeling is classified into three types.

- a. 2D : Two-dimensional representation is used for a flat object.
- b.  $2\frac{1}{2} D$  : This goes somewhat beyond the 2D capability by permitting a three-dimensional object to be represented as long as it has no side-wall details.
- c. 3D : This allows for full three-dimensional modeling of a more complex geometry.

Geometric models in CAD can also be classified as wire-frame models, or solid models. Wire-frame models use inter-connecting lines to depict the object drawn; these inter-connecting lines can sometimes be confusing when used on complex part geometries, as multiple overlapping lines may occur. Solid models are objects that have been modelled in solid three dimensions, providing the user with a vision of the object that is similar to its appearance in reality. This method typically uses solid geometry shapes called **primitives** to construct the object.

### 2. Engineering Analysis

Once a design has been developed, it must then be subjected to engineering analysis. This analysis may include various tests, depending on the product, but may include: stress-strain calculations, heat transfer analysis, or dynamic simulation. These analyses tend to be quite complex, which has led to the development of computer-aided engineering (CAE) software packages, so that complicated engineering analysis may be performed by computer. FEM and dynamic analysis software packages are generally used for this purpose. The engineering analysis includes:

- Mass properties analysis- involving the computation of features on the solid model, such as volume, surface area, weight, and centre of gravity;
- Tolerance analysis- this determines how product tolerances would affect product function and performance, how easy it would be to assemble the product, and how variations in component dimensions may affect the overall size of the assembly;

- Finite element analysis- this aids in stress-strain, heat transfer, fluid flow, and other engineering calculations;
- Kinematic and dynamic analysis- this studies the operation of mechanical linkages and analyzes their motions; and
- Discrete event simulation- this models complex operational systems where events occur at discrete moments in time and affect the status and performance of the system.

### **3. Design Review and Evaluation**

Following comprehensive engineering analysis, the proposed design must be evaluated and reviewed for consistency. Some CAD features that are helpful in evaluating and reviewing a proposed design include:

- Automatic dimensioning- upon model completion, the CAD software can automatically generate the dimensions of the drawn model;
- Error checking- this checks the accuracy and consistency of dimensions and tolerances, to assess whether the proper design documentation format has been followed;
- Animation of discrete-event simulation solutions- this displays the result as a discrete event simulation, where input parameters, probability distributions, and other factors can be changed to assess their effect on the performance of the system being modelled; and
- Plant layout design scores- this provides numerical scores for plant layout designs, based upon such factors as material flow, and closeness ratings.

In many cases, the geometric model is now used to replace the physical prototype that would traditionally be built at this stage. Physical prototypes are usually time-consuming to create, and analyse; and so replacements in the form of rapid prototyping, and virtual prototyping- both based upon the geometric model, may be used instead.

Rapid prototyping is a term applied to a family of fabrication technologies that allow engineering prototypes of solid parts to be made in a minimum lead time, based upon the CAD geometric model. This is done by dividing the solid object into layers, and then defining the area of each layer. The rapid prototyping process then fabricates the object by starting at the base layer, and building towards the top layer. The fidelity of the approximation that is produced by this method is dependent on the layer thickness used at the start (with greater accuracy achieved with thinner layers used).

Virtual prototyping is based upon virtual reality technology, and uses the CAD geometric model to construct a digital mock-up of the product. This mock-up allows the designer to obtain the sensation of the real physical product, without actually building the physical prototype.

Rapid prototyping creates a physical prototype by means of segmenting the CAD geometric model into a series of layers, and building to that specification; while virtual prototyping uses the CAD geometric model to construct a digital mock-up of the product.

A procedure called layering is often helpful in design review. For example, a good application of layering involves over-layering the geometric image of the final shape of the machined part on top of the image of the rough casting. This ensures that sufficient material

is available on the casting to accomplish the final machined dimensions. This procedure can be performed in stages to check each successive step till the processing of the part,

Another related procedure for design review is interference checking. This involves the analysis of an assembled structure in which the risk that the components of the assembly may occupy the same space. This risk occurs in the design of large chemical plants, air-separation cold boxes and other complicated piping structure.

One of the most interesting evaluation features available on some CAD system is kinematics; the available kinematics packages provide the capability to animate the motion of simple designed mechanisms such as hinged components and linkages. This capability enhances the designer's visualization of the operation of the mechanism and helps to ensure against interference with other components without graphical kinematics on a CAD system.

#### **4. Automated Drafting**

Automated drafting involves the creation of hardcopy engineering drawings directly from the CAD database. In some early computer aided design departments, automation of the drafting represented the principal justification for investing in the CAD system. Indeed, CAD systems can increase productivity in the drafting function by roughly five times over manual drafting. Some of the graphics features of computer aided design systems lend themselves especially well to the drafting process. These features include automatic dimensioning generation of crosshatched areas, seating of the drawing and capability to develop sectional views and enlarged views of particular part details, the ability to rotate the part or to perform other transformations of the image (e.g., oblique isometric or perspective views).

### **2.3 CREATING MANUFACTURING DATA BASE**

The important reason for using a CAD system is that it offers the opportunity to develop the database needed to manufacture the product. In the conventional manufacturing cycle, engineering drawings were prepared by design draftsmen and then used by manufacturing engineers to develop the process plan (i.e., route sheets). The activities involved in designing the product were separated from the activities associated with process planning. Basically a two-step procedure was employed. This was both time consuming and involved duplication of effort by design and manufacturing engineers. In an integrated CAD/CAM system, a direct link is established between product design and manufacturing. It is the goal of CAD/CAM not only to automate certain phases of design and certain phases of manufacturing but also to automate the transition from design to manufacturing. Computer based systems have been developed which create much of the data and documentation required to plan and manage the manufacturing operations for the product.

The manufacturing database is an integrated CAD/CAM database. It includes all the data on the product generated during design, i.e., geometry data, bill of material and assembly lists, material specifications, etc. as well as additional data required for manufacturing, much of which is based on the product design. Figure 2.2 shows how the CAD/CAM database is related to design and manufacturing.

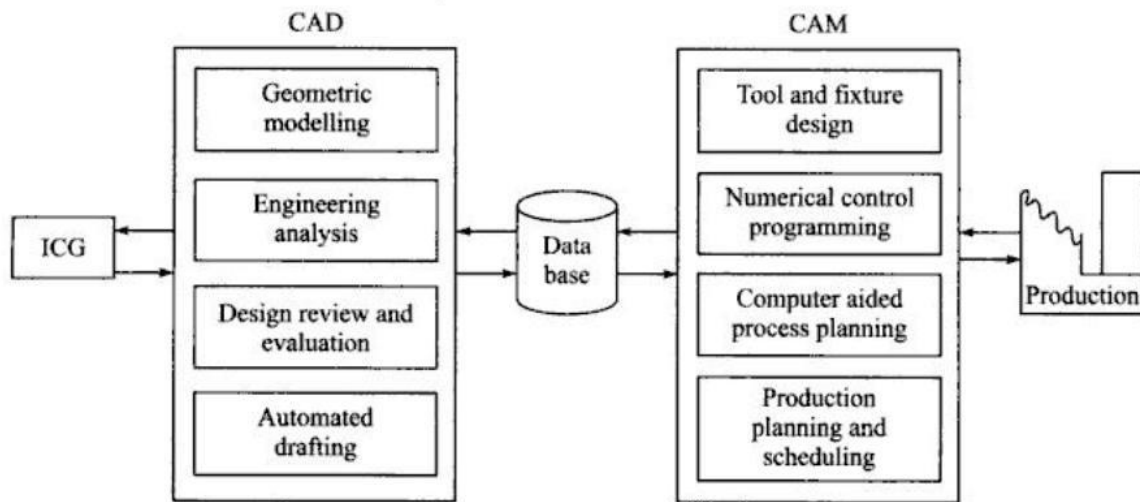

Figure 2.2 Relationship of CAD/CAM database to CAD and CAM

## 2.4 BENEFITS OF CAD

There are many benefits of computer aided design, only some of which can be easily measured. Some of the benefits are intangible which are reflected in improved work quality and more pertinent and usable information. Some of the benefits are tangible which are discussed hereinafter.

1. *Productivity improvement in design:* CAD helps in increased design productivity by reducing the time for developing conceptual design, analysis and drafting. It is also possible to reduce the manpower requirements for a given project. Productivity improvement in computer aided design process is dependent on factors such as;
  - Complexity of the drawing
  - Degree of repetitiveness of features in the designed parts
  - Degree of symmetry in the parts
  - Extensive use of library of user defined shapes and commonly used entities
2. *Shorter lead times:* Interactive CAD is inherently faster than traditional manual design process. CAD tools reduce the number of iterations. It speeds up the task of preparing reports and bill of materials using a CAD system. A finished set of component drawings and documentation can be prepared in a relatively short time. Shorter lead times in design result in reduction of the elapsed time between receipt of customer order and delivery of the finished product. The enhanced productivity of the designers working in CAD environment will reduce the importance of design, engineering analysis and drafting as critical time elements in the overall manufacturing lead time.
3. *Design analysis:* The design analysis routines available in a CAD system help to optimize the design into an appropriate logical work pattern. The use of design analysis software such as finite element analysis and kinematics analysis reduces the time and improves the design accuracy. Instead of having feedback sessions between design and analysis groups, the designer can perform the analysis while working on a CAD workstation. This enhances the concentration of designers, since the process is interactive in nature, Calculation of mass properties can be made almost instantaneously.
4. *Fewer design errors:* Interactive CAD systems have inherent capability for avoiding errors in design, drafting and documentation. These errors occur during manual handling. Errors are avoided because interactive CAD systems perform time consuming and repetitive functions such as multiple symbol placements,



5. *Flexibility in design:* Interactive CAD systems apart from generating designs with repetitive accuracy offers the advantage of easy modification of design to satisfy customer's specific requirements.
6. *Standardization of design, drafting and documentation:* The single database and operating system used in CAD provide a common basis for design, analysis and drafting process with interactive CAD systems, drawings are "standardized" as they are drawn, It is also possible to reuse previous modules in developing a range of products.
7. *Drawings are more understandable:* With the increase in the use of 3D views and solid modelling, it has become easier to comprehend the features of the component readily. One does not have to reconstruct mentally the solid shape from 2D objects. Many software packages allow 3D view generation from a 2D model. This has several advantages from the manufacturing point of view.
8. *Improved procedures for engineering changes:* Control and implementation of engineering changes can be significantly improved with computer-aided design. Original drawings and reports are stored in the database of the CAD system and are easily accessible. Revision information can be retained and new drawings with changes can be created without destroying previous features.
9. *Benefits in manufacturing:* The benefits of computer aided design can be used as a basis for a number of downstream manufacturing operations. Some of the manufacturing benefits are:
  - (a) Tool and fixture design for manufacturing
  - (b) Computer aided process planning
  - (c) Computer aided inspection
  - (d) Preparation of numerical control programs for manufacturing of components on computer numerical control machines
  - (e) Preparation of assembly lists and bill of materials for production
  - (f) Coding and classification of components
  - (g) Production planning and control
  - (h) Assembly sequence planning

## 2.5 CAD SYSTEM HARDWARE

Hardware components for computer aided design are available in a variety of sizes, configurations and capabilities. Hence it is possible to select a CAD system that meets the particular computational and graphics requirements of the user firm. Engineering firms that are not involved in production would choose a system exclusively for drafting and design related functions. Manufacturing firms would choose a system to be part of a company-wide CAD/CAM system.

A modern CAD system is based on interactive computer graphics (ICG). However the scope of CAD includes other computer system as well. For example, computerized design has also been accomplished in a batch mode, rather than in an interactive mode. With interactive graphics the system provides an immediate response to inputs by the user. The user and the system are in direct communication with each other. The user enters commands and responds to the questions generated by the system. Presently it is restricted to CAD systems which utilize interactive computer graphics. Typically a stand-alone CAD system would include the following hardware components:

Graphics terminal	Operator output devices
Operator input devices	Secondary storage
Central processing unit (CPU)	

These hardware components would be arranged in a configuration as shown in Figure 2.3.

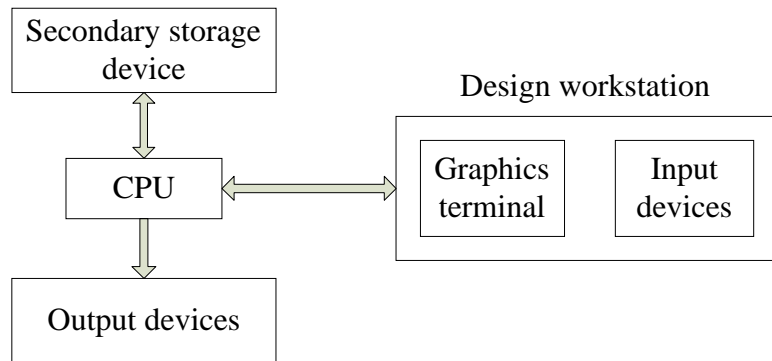

Figure 2.3 Typical configuration of hardware components in a standalone CAD system

### 2.5.1 DESIGN WORKSTATION

The CAD workstation is the system interface with the outside world. It represents an important factor in determining how convenient and efficient it is for a designer to use the CAD system. The workstation must accomplish five functions:

1. It must interface with the central processing unit.
2. It must generate a steady graphic image for the user.
3. It must provide digital descriptions of the graphic image.
4. It must translate computer commands into operating functions.
5. It must facilitate communication between the user and the system.

The use of interactive graphics has been found to be the best approach to accomplish these functions. A typical interactive graphics workstation would consist of the following hardware components:

- Graphics terminal
- Operator input devices

### 2.5.2 GRAPHIC TERMINAL

There are various different approaches which have been applied to the development of graphics terminals. The technology continues to improve their products and reduce their costs.

#### (I) Image Generation in Computer Graphics

All computer graphics terminals which are in use today use the cathode ray tube (CRT) as the display device. Television sets use a form of the same device as the picture tube. The operation of the CRT is shown in Figure 2.4. A heated cathode emits a high speed electron beam onto a phosphor-coated glass screen. The electrons energize the phosphor coating causing it to glow at the points where the beam makes contact. By focusing the electron beam, changing its intensity and controlling its point of contact against the phosphor coating through the use of a deflector system, the beam can be made to generate a picture on the CRT screen.

There are two basic techniques used in current computer graphics terminals for generating the image on the CRT screen. They are:

1. Stroke writing
2. Raster scan

Other names for the stroke writing technique include line drawing, random position, vector writing, and directed beam. Other names for the raster scan technique include digital TV and scan graphics.

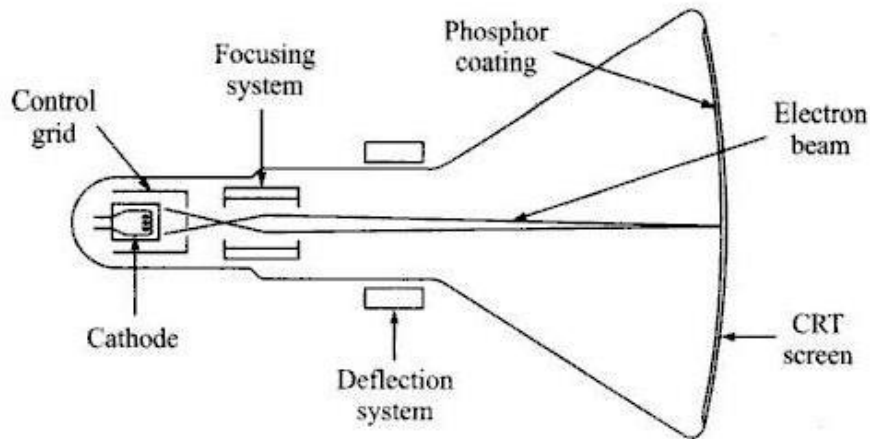

Figure 2.4 Diagram of cathode ray tube (CRT)

The stroke writing system uses an electron beam which operates like a pencil to create a line image on the CRT screen. The image is constructed out of a sequence of straight line segments. Each line segment is drawn on the screen by directing the beam to move from one point on the screen to the next where each point is defined by its  $x$  and  $y$  coordinates. The process is illustrated in Figure 2.5.

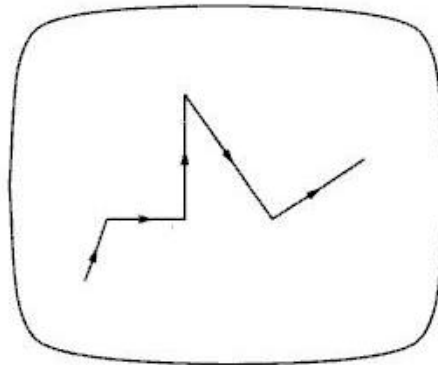

Figure 2.5 Stroke writing for generating images in computer graphics

Although the procedure results in images composed of only straight lines, smooth curves can be approximated by making the connecting line segments short enough. In the raster scan approach, the viewing screen is divided into a large number of discrete phosphor picture elements called pixels. The matrix of pixels constitutes the raster. The number of separate pixels in the raster display might typically range from  $256 \times 256$  to  $1024 \times 1024$  (a total of over 65,000 points to 1,000,000 points). Each pixel on the screen can be made to glow with a different brightness. Colour screens provide for the pixels to have different colours as well as brightness.

During operation an electron beam creates the image by sweeping along a horizontal line on the screen from left to right and energizing the pixels in that line during the sweep when the sweep of one line is completed. The electron beam moves to the next line below and proceeds in a fixed pattern as portrayed in Figure 2.6. After sweeping the entire screen the process is repeated at a rate of 30 to 60 entire scans of the screen per second.

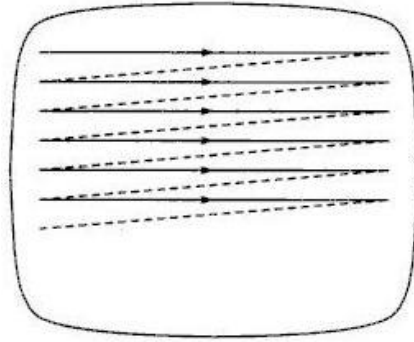

Figure 2.6 Raster scan approach for generating images in computer graphics

## **(II) Graphics Terminals**

The two approaches described earlier are used till the majority of current day CAD graphics terminals. There are also a variety of other technical factors which result in different types of graphics terminals. These factors include the type of phosphor coating on the screen, whether the colour is required, the pixel density and the amount of computer memory available to generate the picture. The three types of graphics terminals are:

- (a) Directed beam refresh tube (DBRT)
- (b) Direct view storage tube (DVST)
- (c) Raster scan terminals (Digital TV)

### **(a) Directed Beam Refresh Tube (DBRT)**

The directed beam refresh terminal utilizes the stroke writing approach to generate the image on the CRT screen. The term refresh in the name refers to the fact that the image must be regenerated many times per second in order to avoid noticeable flicker of the image. The phosphor elements on the screen are capable of maintaining their brightness for only a short time. In order for the image to be continued, these picture tubes must be refreshed by causing the directed beam to retrace the image repeatedly on densely filled screens (very detailed line images or many characters of text). It is difficult to avoid flickering of the image with this process.

There are several advantages associated with the directed beam refresh systems. Because the image is being continually refreshed, selective erasure and alteration of the image is readily accomplished. It is also possible to provide animation of the image with a refresh tube.

The directed beam refresh system is the oldest of the modern graphics display technologies. Other names sometimes used to identify this system include vector refresh and stroke writing refresh. Early refresh tubes were very expensive, but the steadily decreasing cost of solid state circuitry has brought the price of these graphics systems down to a level which is competitive with other types.

### **(b) Direct View Storage Tube (DVST)**

DVST terminals also use the stroke writing approach to generate the image on the CRT screen. The term storage tube refers to the ability of the screen to retain the image which has been projected against it, thus avoiding the need to rewrite the image constantly. What makes this possible is the use of an electron flood gun directed at the phosphor coated screen which keeps the phosphor elements illuminated once they have been energized by the stroke writing

electron beam. The resulting image on the CRT screen is flicker free. Lines may be readily added to the image without concern over their effect on image density or refresh rates. However, the penalty associated with the storage tube is that individual lines cannot be selectively removed from the image.

Storage tubes have been the low cost terminals and are capable of displaying the large amounts of data either graphical or textual. Because of these features there are probably more storage tube terminals in service industry. The principal disadvantage of a storage CRT is that selective erasure is not possible instead if the user wants to change the picture. The change will not be manifested on the screen until the entire picture is regenerated. Other disadvantages include its lack of colour capability, the inability to use a light pen as a data entry device and its lack of animation capability.

### **(c) Raster Scan Terminals (Digital TV)**

Raster scan terminals operate by causing an electron beam to trace a zigzag pattern across the viewing screen. The operation is similar to that of a commercial television set. The difference is that a TV set uses analog signals originally generated by a video camera to construct the image on the CRT screen, while the raster scan ICG terminal uses digital signals generated by a computer. For this reason the raster scan terminals used in computer graphics are sometimes called digital TVs.

The introduction of the raster scan graphics terminal using a refresh tube had been limited by the cost of computer memory. For example, the simplest and lowest cost terminal in this category uses only two beam intensity levels: ON or OFF. This means that each pixel in the viewing screen is either illuminated or dark. A picture tube with 256 lines of resolution and 256 addressable points per line to form the image would require 256 x 256 or over 65,000 bits of storage. Each bit of memory contains the ON/OFF status of the corresponding pixel on the CRT screen. This memory is called the frame buffer or refresh buffer.

The picture quality can be improved in two ways by increasing the pixel density or adding a gray scale (or colour). Increasing pixel density for the same size screen means adding more lines of resolution and more addressable points per line. A 1024 x 1024 raster screen would require more than 1 million bits of storage in the frame buffer. A gray scale is accomplished by expanding the number of intensity levels, which can be displayed on each pixel to store the intensity level. Two bits are required for four levels, three bits for eight levels and so on. Five or six bits would be needed to achieve an approximation of a continuous gray scale. For a colour display three times as many bits are required to get various intensity levels for each of the three primary colours—red, blue and green. A raster scan graphics terminal with high resolution and gray scale can require a very large capacity refresh buffer. Until recent developments in memory technology, the cost of this storage capacity was prohibitive for a terminal with good picture quality.

The capability to achieve colour and animation was not possible except for very low resolution levels. It is now possible to manufacture digital TV systems for interactive computer graphics at prices, which are competitive with the other two types. The advantages of the present raster scan terminals include the feasibility to use low cost TV monitors, colour capability and the capability for animation of the image. Many of the important characteristics of the three types of graphics terminals are summarized in Table 2.1.

Table 2.1 Comparison of Graphics Terminal Features

		DBRT	DVST	Digital TV
1	Image generation	Stroke writing	Stroke writing	Raster scan
2	Picture quality	Excellent	Excellent	Moderate to Good
3	Data content	Limited	High	High
4	Selective erase	Yes	No	Yes
5	Gray scale	Yes	No	Yes
6	Colour capability	Moderate	No	Yes
7	Animation capability	Yes	No	Moderate

### 2.5.3 OPERATOR INPUT DEVICES

Graphics input devices are provided at the graphics workstation to facilitate convenient communication between the user and the system. Workstations generally have several types of input devices to allow the operator to select the various pre-programmed input functions. These functions permit the operator to create or modify an image on the CRT screen or to enter alphanumeric data into the system. This results in a complete part on the CRT screen as well as a complete geometric description of the part in the CAD database.

Different CAD system vendors offer different types of (graphics) operator input devices. These devices can be divided into three general categories:

- (a) Cursor control devices
- (b) Digitizers
- (c) Alphanumeric and other keyboard terminals

Cursor control devices and digitizers are both used for graphical interaction with the system. Keyboard terminals are used as input devices for commands and numerical data. There are two basic types of graphical interaction accomplished by means of cursor control and digitizing creating and positioning new items on the CRT screen. Pointing at or otherwise identifying locations on the screen, usually associated with existing images ideally, a graphical input device should lend itself to both of these functions. However this is difficult to accomplish with a single unit and that is why most workstations have several different input devices.

#### (a) Cursor Control Devices

The cursor manually takes the form of a bright spot on the CRT screen that indicates where lettering or drawing will occur. The computer is capable of reading the current position of the cursor. Hence the user's capability to control the cursor position allows locational data to be entered into the CAD system database. A typical example would be for the user to locate the cursor to identify the starting point of a line. Another, more sophisticated case would be for the user to position the cursor to select an item from a menu of functions displayed on the screen.

For instance, the screen might be divided into two sections one of which is an array of blocks which correspond to operator input functions. The user simply moves the cursor to the desired block to execute the particular function. There are a variety of cursor control devices which have been employed in CAD systems. These include:

- |                              |                       |
|------------------------------|-----------------------|
| Thumb wheels                 | Light pen             |
| Direction keys on a keyboard | Electronic tablet/pen |
| Joysticks                    | Mouse                 |
| Tracker ball                 |                       |

The first four items in the list provide control over the cursor without any direct physical contact of the screen by the user. The last two devices in the list require the user to control the cursor by touching the screen with a pen type device.

The thumb wheel device uses two thumb wheels: one to control the horizontal position of the cursor, the other to control the vertical position. This type of device is often mounted as an integral part of the CRT terminal. The cursor in this arrangement is often represented by the intersection of a vertical line and a horizontal line displayed on the CRT screen. The two lines are like cross hairs in a gun sight which span the height and width of the screen.

Direction keys on the keyboard are another basic form of cursor control used not only for graphics terminals but also for CRT terminals without graphics capabilities. Four keys are used for each of the four directions in which the cursor can be moved (right or left and up or down).

The joystick apparatus is pictured in Figure 2.7. It consists of a box with a vertical toggle stick that can be pushed in any direction to cause the cursor to be moved in that direction. The joystick gets its name from the control stick that was used in old air planes.

The tracker ball is pictured in Figure 2.7. Its operation is similar to that of the joystick except that an operator controlled ball is rotated to move the cursor in the desired direction on the screen.

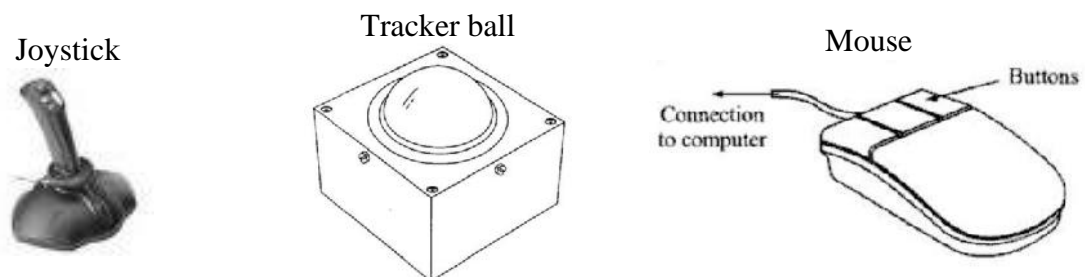

Figure 2.7 Input devices

The light pen is a pointing device in which the computer seeks to identify the position where the light pen is in contact with the screen. Contrary to what its name suggests the light pen does not project light. Instead it is a detector of light on the CRT screen and uses a photodiode, phototransistor or some other form of light sensor. The light pen can be utilized with a refresh type CRT but not with a storage tube. This is because the image in the refresh tube is being generated in time sequence. The time sequence is so short that the image appears continuous to the human eye.

However, the computer is capable of discerning the time sequence and it coordinates this timing with the position of the pen against the screen. In essence the system is performing as an optical tracking loop to locate the cursor or to execute some other input function.

The tablet and pen in computer graphics describe an electronically sensitive tablet used in conjunction with an electronic stylus. The tablet is a flat surface separate from the CRT screen on which the user draws with the pen like stylus to input instructions or to control the

cursor. It should be noted that thumb wheels direction keys, joysticks and tracker balls are generally limited in their functions to cursor control.

The light pen and tablet/pen are typically used for other input functions as well as cursor control. Some of these functions are:

- Selecting from a function menu.
- Drawing on the screen or making strokes on the screen or tablet which indicate what image is to be drawn.
- Selecting a portion of the screen for enlargement of an existing image,

A light pen resembles a fountain pen in the method of holding, but it works on the principle of light rather than ink, hence the name. Light pens are not used for writing on the screen as is erroneously believed by many but actually only to detect the presence of light on the screen as shown in Figure 2.8, with the help of a light detecting resistor. Their normal use in graphic applications is to identify the objects or locations on the display screen for possible graphics handling. These are to be used only with refresh type display devices. The resolution of the light pen is poor, as the field of view of the photosensitive element is conical. Since the light pen points to the graphic display directly, it is a natural graphic interactive tool. However, as the operator has to hold the light pen against the gravity along with its cable connecting the graphics adapter card for making any selection, ergonomically it is inconvenient to use it over long periods.

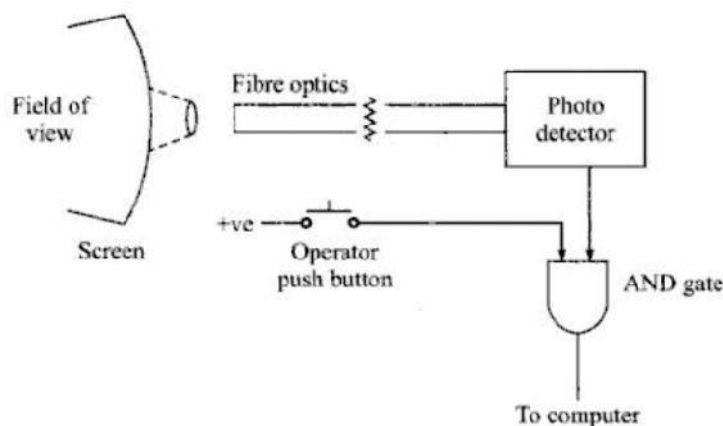

Figure 2.8 Light pen

The mouse shown in Figure 2.7 is the pointing device, which has been gaining importance with the advent of the microprocessors, and the pull down menus associated with the application software. The mouse operates on three basic principles-Mechanical, Optical and Opto• mechanical. The mechanical mouse contains a free buttons floating ball with rubber coating on the underside which, when moved on a firm plane surface would be able to follow the movement of the hand. The motion of the ball is resolved into  $x$  and  $y$  motions by means of the two rollers pressed against the ball. They in turn control the cursor on the screen, which can then be utilized for any desired applications by means of the clicking of the buttons on the mouse.

This can only suffice to point, on the screen but not for giving positional data. In case of the optical mouse, a special reflective plain surface with etched fine grids is required. The LEDs present inside the mouse (in place of the rubber ball) would reflect the number of grid lines crossed in  $x$  and  $y$  directions, thereby showing the distance moved. The life of the optical mouse is high since it has no moving parts, but it has not gained as much acceptance as the



mechanical mouse because of the special surface needed for its operation. The operation of the opto-mechanical mouse is similar to that of the mechanical mouse, but the position resolvers used are based on the optical principle.

### **(b) Cursor Control Devices**

The digitizer shown in Figure 2.9 is an operator input device which consists of a large, smooth board (the appearance is similar to a mechanical drawing board) and an electronic tracking device which can be moved over the surface to follow existing lines. It is a common technique in CAD systems for taking  $x, y$  coordinates from a paper drawing.



Figure 2.9 Digitizer

The electronic tracking device contains a switch for the user to record the desired  $x$  and  $y$  coordinate positions. The coordinate can be entered into the computer memory or stored on an off-line storage medium such as magnetic tape. High resolution digitizers typically with a large board (e.g. 42 x 60 inch) can provide resolution and accuracy on the order of 0.001 in. It should be mentioned that the electronic tablet and pen can be considered to be a small low-resolution digitizer.

It would be inadequate in three-dimensional mechanical design work since the digitizer is limited to two dimensions. For two-dimensional drawings, drafters can readily adapt to the digitizer because it is similar to their drafting boards. It can be tilted, raised or lowered to assume a comfortable position for the drafter.

The digitizer can be used to digitize line drawings. The user can input data from a rough schematic or large layout drawing and edit the drawing to the desired level of accuracy and detail. The digitizer can also be used to free hand a new design with subsequent editing to finalize the drawing.

### **(c) Keyboard terminals**

Several forms of keyboard terminals are available as CAD input device. The most familiar type is the alphanumeric terminal, which is available with nearly all interactive graphics systems. The alphanumeric terminal can be either a CRT or a hard-copy terminal, which prints on paper. For graphics the CRT has the advantage because of its faster speed, the ability to easily edit, and the avoidance of large volumes of paper. On the other hand, a permanent record is sometimes desirable and this is most easily created with a hard-copy terminal. Many CAD systems use the graphics screen to display the alphanumeric data, but there is an advantage in having a separate CRT terminal so that the alphanumeric messages can be created without disturbing or overwriting the image on the graphics screen.

The alphanumeric terminal is used to enter commands, functions and supplemental data to the CAD system. This information is displayed for verification on the CRT or typed to paper. The system also communicates back to the user in a similar manner. The computer, as part of the interactive procedure can display menu listings, program listings, error messages and so forth.

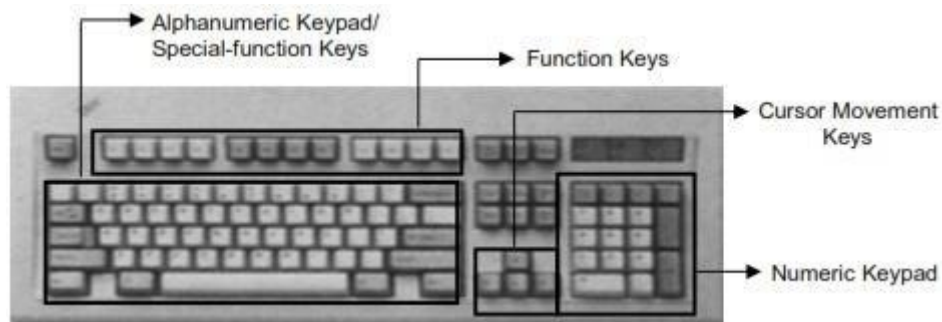

Figure 2.10 Keyboard

Some CAD systems make use of special function keyboards, as pictured in Figure 2.10. These function keyboards are provided to eliminate extensive typing of commands or calculate coordinate positions and other functions. The number of function keys varies from about 8 to 80. The particular function corresponding with each button is generally under computer control so that the button function can be changed as the user proceeds from one phase of the design to the next. In this way the number of alternative functions can easily exceed the number of buttons on the keyboard. Also lighted buttons are used on the keyboards to indicate which functions are possible in the current phase of design activity. A menu of the various function alternatives is typically displayed on the CRT screen for the user to select the desired function.

Besides the above commonly used devices, the followings are also used as input devices.

#### **(d) Scanner**

Scanner is an input device used for direct data entry from the source document into the computer system. This is shown in Figure 2.11. It converts the document image into digital form so that it can be fed into the computer. Capturing information like this reduces the possibility of errors typically experienced during large data entry. Hand-held scanners are commonly seen in big stores to scan codes and price information for each of the items. They are also termed the bar code readers.

#### **(e) Barcode**

A bar code is a set of lines of different thicknesses that represent a number. Bar Code Readers are used to input data from bar codes. Most products in shops have bar codes on them. Bar code readers work by shining a beam of light on the lines that make up the bar code and detecting the amount of light that is reflected back. This is as shown in Figure 2.11.

#### **(f) Touch Screen**

It allows the user to operate/make selections by simply touching the display screen. Common examples of touch screen include information kiosks, and bank ATMs.

#### **(g) Digital camera**

A digital camera can store many more pictures than an ordinary camera. Pictures taken using a digital camera are stored inside its memory and can be transferred to a computer by

connecting the camera to it. A digital camera (Figure 2.11) takes pictures by converting the light passing through the lens at the front into a digital image.



Scanner

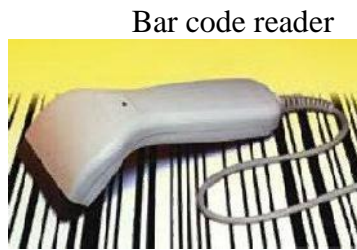

Bar code reader



Camera

Figure 2.11 Input devices

#### **(h) The speech input device**

The “Microphones - Speech Recognition” is a speech Input device. To operate it we require using a microphone to talk to the computer. Also we need to add a sound card to the computer. The Sound card digitizes audio input into 0/1s. A speech recognition program can process the input and convert it into machine-recognized commands or input.

### **2.5.4 OPERATOR OUTPUT DEVICES**

There are various types of output devices used in conjunction with a computer aided design system. These output devices include;

- Pen plotters
- Hardcopy units
- Electrostatic plotters
- Printers
- Computer-output-to-micro-film (COM) units

#### **(a) Pen plotters**

The accuracy and quality of the hardcopy plot produced by a pen plotter are considerably greater than the apparent accuracy and quality of the corresponding image on the CRT screen. In case of the CRT image, the quality of the picture is degraded because of lack of resolution and because of losses in the digital-to-analog conversion through the display generators. On the other hand, a high precision pen plotter is capable of achieving a hard-copy drawing whose accuracy is nearly consistent with the digital definitions in the CAD database.

The pen plotter uses a mechanical ink pen (either wet ink or ball point) to write on paper through relative movement of the pen and paper. There are two basic types of pen plotters currently in use:

- Drum plotters
- Flat-bed plotters

The drum plotter, shown in Figure 2.12, is generally the least expensive. It uses a round drum, usually mounted horizontally and a slide, which can be moved along a track mounted axially with respect to the drum. The paper is attached to the drum and the pen is mounted on the slide. The relative motion between pen and paper is achieved by coordinating the rotation of the drum with the motion of the slide. The drum plotter is fast and it can make drawings of virtually unlimited length. The length of the drum however limits the width. These lengths typically range between 8½ inch (216 mm) and 42 inch (1067 mm).

The flat-bed plotter, shown in Figure 2.12, is more expensive. It uses a flat drawing surface to which the paper is attached on some models. The surface is horizontal while other models use a drawing surface which is mounted in a nearly vertical orientation to conserve floor space. This type is shown in Figure 2.12. Parallel tracks are located on two sides of the flat surface. A bridge is driven along these tracks to provide the x-coordinate motion. Attached to the bridge is another track on which rides a writing head movement of the writing head relative to the bridge produces the y-coordinate motion. The writing head carries the pen or pencil which can be raised or lowered to provide contact with the paper as desired. The size of these automated drafting tables can range up to roughly 5 ft (1.5 m) by 20 ft (6.1 m) with plotting accuracies approaching  $\pm 0.001$  in ( $\pm 0.025$  mm).

The pen plotter accepts digitized data either on-line from the computer or off-line in the form of magnetic tape or punched tape on modern pen plotters. A microprocessor is often used as the control unit. This allows certain shapes such as circles and ellipses to be programmed in the form of simple instructions to the plotter. In this way the digital data for a complicated shape can be made more compact and efficient.

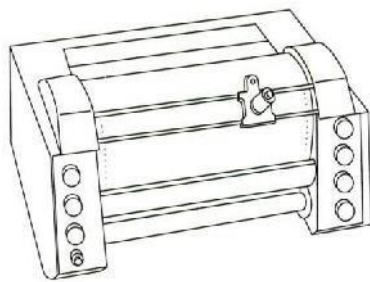

Drum plotter

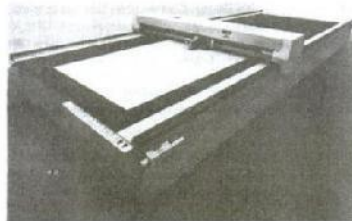

Flat bed plotter



Belt bed plotter

Figure 2.12 Pen plotters

Many plotters work with several pens of different colours to achieve multi-colour plots. Also in some models the pen may be replaced by a highly focused high intensity light and the conventional drafting paper by a photosensitive paper. This arrangement would be used for certain artwork applications. Another option available on a flat-bed plotter is to combine the plotter function with the operation of a digitizer. Such a device is called a digitizer plotter.

### (b) Hard copy units

A hard copy unit is a machine that can make copies from the same image data displayed on the CRT screen. The image on the screen can be duplicated in a matter of seconds. The copies can be used as records of intermediate steps in the design process or when rough hard copies of the screen are needed quickly. The hardcopies produced from these units are not suitable as final drawings because the accuracy and quality of the reproduction is not nearly as good as the output of a pen plotter,

Most hardcopy units are dry silver copiers that use light sensitive paper exposed through a narrow CRT window inside the copier. The window is typically 8½ inch (216 mm) corresponding to the width of the paper, by about ½ inch (12 mm) wide. The paper is exposed by moving it past the window and coordinating the CRT beam to gradually transfer the

image. A heated roller inside the copier is used to develop the exposed paper. The size of the paper is usually limited on these hardcopy units to 8½ by 11 in. Another drawback is that the dry silver copies will darken with time when they are left exposed to normal light.

### **(c) Electrostatic plotters**

Hardcopy units are relatively fast but their accuracy and resolution are poor. Pen plotters are highly accurate but plotting time can take many minutes. The electrostatic plotter offers a compromise between these two types in terms of speed and accuracy. It is almost as fast as the hardcopy unit and almost as accurate as the pen plotter. The electrostatic copier consists of a series of wire styli mounted on a bar which spans the width of the charge sensitive paper. The styli have a density of up to 200 per linear inch. The paper is gradually moved past the bar and certain styli are activated to place dots on the paper by coordinating the generation of the dots with the paper travel. The image is progressively transferred from the database into hardcopy form. The dots overlap each other slightly to achieve continuity. For example, a series of adjacent dots gives the appearance of a continuous line.

A limitation of the electrostatic plotter is that the data must be in the raster format (i.e., in the same format used to drive the raster-type CRT) in order to be readily converted into hardcopy using the electrostatic method. If the data are not in raster format, some type of conversion is required to change them into the required format. The conversion mechanism is usually based on a combination of software and hardware.

An advantage of the electrostatic plotter, which is shared, with the drum type pen plotter is that the length of the paper is virtually unlimited. Typical plotting widths might be up to 6 ft (1.83 m). Another advantage is that the electrostatic plotter can be utilized as a high-speed line printer, capable of up to 1200 lines of text per minute.

### **(d) Printer**

Printers are used to produce paper (commonly known as hardcopy) output. Based on the technology used, they can be classified as Impact or Non-impact printers. Impact printers use the typewriting printing mechanism wherein a hammer strikes the paper through a ribbon in order to produce output. Dot-matrix and character printers fall under this category. Non-impact printers do not touch the paper while printing. They use chemical, heat or electrical signals to etch the symbols on paper. Inkjet, Deskjet, Laser, Thermal printers fall under this category of printers. There are two basic qualities associated with printers: resolution, and speed. Print resolution is measured in terms of number of dots per inch (dpi). Print speed is measured in terms of number of characters printed in a unit of time and is represented as characters-per-second (cps), lines-per-minute (lpm), or pages-per-minute (ppm).

### **(e) Computer output to Microfilm (COM) Units**

COM units reproduce the drawings on microfilm rather than as full size engineering drawings. It is an expensive piece of equipment. However, for the large corporation able to afford a COM unit, there are several important advantages. One advantage is storage capability. A large engineering department may have tens of thousands of engineering drawings to be stored. Reducing the size of each drawing to microfilm achieves a significant storage benefit. If a full size hard copy drawing is ever required, the microfilm can be easily retrieved to be photographically enlarged to full size. Another advantage is speed. COM units produce a microfilm copy much faster than a pen plotter, perhaps several hundred times faster for a complicated line drawing. Computer output to microfilm is also faster than electrostatic plotters. Disadvantages of the COM process are that the user cannot write notes

on the microfilm as is possible with a paper copy. Also enlargements of the microfilm onto paper, although adequate, are not of as high quality as the output from a pen plotter.

## **2.6 SOFTWARE FOR GRAPHIC SYSTEM**

CAD software provides engineers with the tools needed to perform their technical jobs efficiently and free them from the tedious and time consuming tasks that require little or no technical expertise. Experience has shown that CAD software speeds the design process, therefore increasing productivity, innovation and creativity of designers. In some design cases such as VLSI, CAD software has provided the only means to meet the new technological design and production requirements of increased accuracy and uniformity. The need for the software in the future will be even greater due to the expected intricate design and manufacturing requirements.

An investigation of existing software in general reveals that it has common characteristics regardless of the hardware it runs on. It is an interactive program typically written in a standard programming language. It is hardware-dependent and seems different to the user from conventional software due to the user interface. The database structure and database management system of the software determines its quality, speed and ease of information retrieval.

The most important characteristic of CAD software is its fully three-dimensional, associative, centralized and integrated database. Such a database is always rich in information needed for both the design and manufacturing processes. The centralized concept implies that any change in or addition to a geometric model in one of its views is automatically reflected in the existing views or any views that may be defined later. The integrated concept implies that a geometric model of an object can be utilized in all various phases of a product cycle. The associativity concept implies that input information can be retrieved in various forms. For example, if the two end points of a line are input the line length and its dimension can be output.

CAD software is typically a large complex program that has been developed over the years. Users of the software are usually faced with learning its related semantics and syntax of its user interface. Semantics specifies how the software functions and what information is needed for each operation on an object. For example, a block requires three lengths and an orientation to create.

Syntax defines the formats of inputs and outputs. It is considered the grammar of the software. It specifies the rules that users must follow to achieve the desired semantics. Performance is another common characteristic of software. The larger the number of interactive users, the longer the interactive response time. The software occasionally "locks" and ceases to respond to or accept user commands. This is typically referred to as "system crash". When this happens, the user loses the work performed after the last filing or save command is issued and rebooting the system is required. This is why users are always advised to file or save their work frequently.

### **2.6.1 Graphics Software**

The graphics software is the collection of programs written to make it convenient for a user to operate the computer graphics system. It includes programs to generate images on the CRT screen, to manipulate the images and to accomplish various types of interaction between the user and the system. In addition to the graphics software there may be additional programs

for implementing certain specialized functions related to CAD/CAM. This includes design analysis programs (e.g. finite element analysis and kinematic simulation) and manufacturing planning programs (e.g. automated process planning and numerical control part programming).

The graphics software for a particular computer graphics system is very much a function of the type of hardware used in the system. The software must be written specifically for the type of CRT and the types of input devices used in the system. The details of the software for a stroke writing CRT would be different than for a raster scan CRT. The differences between storage tube and a refresh tube would also influence the graphics software. Although these differences in software may be invisible to the user to some extent, they are important considerations in the design of an interactive computer graphics system. Newman and Sproull listed six "ground rules" that should be considered in designing graphics software.

- **Simplicity.** The graphics software should be easy to use.
- **Consistency.** The package should operate in a consistent and predictable way to the user.
- **Completeness.** There should be no inconvenient omissions in the set of graphics functions.
- **Robustness.** The graphics system should be tolerant of minor instances of misuse by the operator.
- **Performance.** Within limitations imposed by the system hardware, the performance should be exploited as much as possible by software. Graphics programs should be efficient and speed of response should be fast and consistent.
- **Economy:** Graphics programs should not be so large or expensive as to make their use prohibitive.

### **Software Configuration of a Graphics System**

In the operation of the graphics system by the user, a variety of activities takes place which can be divided into three categories:

- Interact with the graphics terminal to create and alter images on the screen.
- Construct a model of something physical out of the images on the screen. The models are sometimes called application models.
- Enter the model into computer memory and/or secondary storage.

In working with the graphics system, the user performs these various activities in combination rather than sequentially. The user constructs a physical model and inputs it to memory by interactively describing images to the system. The reason for separating these activities in this fashion is that they correspond to the general configuration of the software package used with the interactive computer graphics system. The graphics software can be divided into three modules according to a conceptual model suggested by Foley and Van Dam,

- The graphics package (also called the graphics system)
- The application program
- The application database

This software configuration is illustrated in Figure 2.13. The central module is the application program. It controls the storage of data into and retrieves data out of the application database. The application program is driven by the user through the graphics package which is also known as the graphics system.

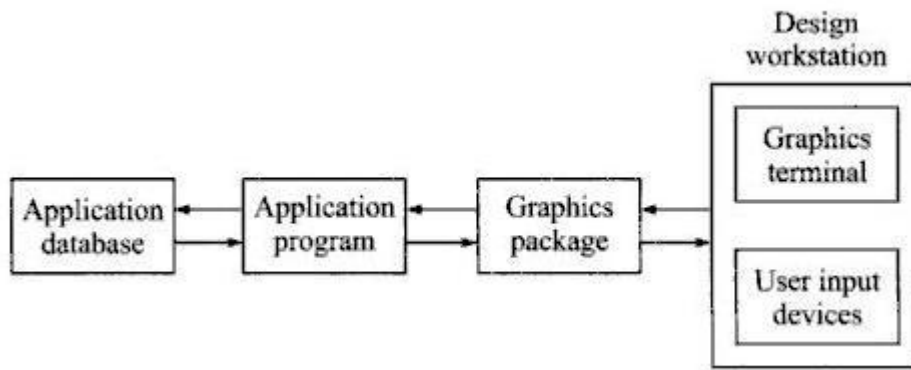

Figure 2.13 Model of graphics software configuration

The application program is implemented by the user to construct the model of a physical entity whose image is to be viewed on the graphics screen. Application programs are written for particular problem areas. Problem areas in engineering design would include architecture, construction, mechanical components, electronics, chemical engineering and aerospace engineering. Problem areas other than design would include flight simulators, graphical display of data, mathematical analysis and even art work. In each case, the application software is developed to deal with images and conventions which are appropriate for that field.

The graphics package is the software support between the user and the graphics terminal. It manages the graphical interaction between the user and the system. It also serves as the interface between the user and the application software. The graphics package consists of input subroutines and output subroutines. The input routines accept input commands and data from the user and forward them to the application program. The output subroutines control the display terminal and convert the application models into two-dimensional or three-dimensional graphical pictures.

The third module in the ICG software is the database. The database contains mathematical, numerical and logical definitions of the application models such as electronic circuits, mechanical components, automobile bodies and so on. It also includes alphanumeric information associated with the models, such as bills of materials, mass properties and other data. The contents of the database can be readily displayed on the CRT or plotted out in the hard copy form.

### 2.6.2 Functions of a graphics package

The function of the graphics software for a CAD system is to provide graphics capabilities so that the various applications can make use of them to help solve design problems. As a result of this objective, the graphics software has to be written and organized into a structure that is sufficient to meet the requirements of many different and diverse applications of CAD. A graphics package should essentially provide a system for handling user actions, a set of basic graphic functions and utilities and a system for the operation of application programs. It is of paramount importance that a graphics package be designed in such a manner as to allow applications systems to be incorporated into the CAD system without the application programmer having to be concerned with low-level data, detail system programming or peripheral handling.



To fulfil its role in the software configuration, the graphics package must perform a variety of different functions. These functions can be grouped into function sets. Each set accomplishes a certain kind of interaction between the user and the system. Some of the common function sets are:

- (a) Generation of graphic elements
- (b) Transformations
- (c) Display control and windowing functions
- (d) Segmenting functions
- (e) User input functions

#### **(a) Generation of graphics elements**

A graphic element in computer graphics is a basic image entity such as a dot (or point), line segment, circle and so on. The collection of elements in the system could also include alphanumeric characters and special symbols. There is often a special hardware component in the graphic system associated with the display of many of the elements. This speeds up the process of generating the element. The user can construct the application model out of a collection of elements available in the system. The term *primitive* is often used in reference to graphic elements. Accordingly, a primitive is a three-dimensional graphic element such as a sphere, cube or cylinder. In three-dimensional wire frame models and solid modelling, primitives are used as building blocks to construct the 3D model of the particular object of interest to the user.

#### **(b) Transformations**

Transformations are used to change the image on the display screen and to reposition the item in the database. Transformations are applied to the graphic elements in order to aid the user in constructing an application model.

The geometry traditionally followed is the Euclidean geometry. In the traditional sense we follow the Cartesian coordinate system specified by the *X*, *Y* and *Z* coordinate directions. The three axes are mutually perpendicular and would follow the right hand system. In handling of geometrical information, many a times it becomes necessary to transform the geometry. The transformations actually convert the geometry from one coordinate system to the other. These transformations include enlargement and reduction of the image by a process called scaling, repositioning the image or translation and rotation.

#### **(c) Display control and windowing functions**

This function set provides the user with the ability to view the image from the desired angle and at the desired magnification. In effect it makes use of various transformations to display the application model the way the user wants it shown. This is sometimes referred to as windowing because the graphic screen is like a window being used to observe the graphics model. The notion is that the window can be placed wherever desired in order to look at the object being modelled.

Another aspect of display control is hidden line removal. In most graphic systems, the image is made up of lines used to represent a particular object. Hidden line removal is the procedure by which the image is divided into its visible and invisible (or hidden) lines. In some systems, the user must identify which lines are invisible so that they can be removed from the image to make it more understandable. In other systems the graphics package is sufficiently sophisticated to remove the hidden lines from the picture automatically.

#### **(d) Segmenting functions**

Segmenting functions provide users with the capability to selectively replace, delete or otherwise modify portions of the image. The term *segment* refers to a particular portion of the image which has been identified for purposes of modifying it. The segment may define a single element or logical grouping of elements that can be modified as a unit.

Storage type CRT tubes are unsuited to segmenting functions. To delete or modify a portion of the image on a storage tube requires erasing the entire picture and redrawing it with the changes incorporated. Raster scan refresh tubes are ideally suited to segmenting functions because the screen is automatically redrawn 30 or more times per second. The image is regenerated each cycle from a display file, a file used for storage that is part of the hardware in the raster scan CRT. The segment can readily be defined as a portion of that display file by giving it a name. The contents of that portion of the file would then be deleted or altered to execute the particular segmenting function.

#### **(e) User input functions**

User input functions constitute a critical set of functions in the graphics package because they permit the operator to enter commands or data to the system. The entry is accomplished by means of operator input devices. The user input functions must of course be written specifically for the particular component of input devices used on the system. The extent to which the user input functions are well designed has a significant effect on how "friendly" the system is to the user, that is how easy it is to work on the system.

The input functions should be written to maximize the benefits of the interactive feature of ICG. The software design compromise is to find the optimum balance between providing enough functions to conveniently cover all data entry situations without flooding the user with so many commands that they cannot remember. One of the goals that are sought after by software designers in computer graphics is to simplify the user interface so that a designer with little or no programming experience can function effectively on the system.

### **2.6.3 Constructing the geometry**

#### **(a) The use of graphics elements**

The graphics system accomplishes the definition of the model by constructing it out of graphic elements. These elements are called by the user during the construction process and added one by one to create the model. There are several aspects about this construction process which will be discussed.

First, as each new element is being called but before it is added to the model, the user can specify its size, its position and its orientation. These specifications are necessary to form the model to the proper shape and scale. For this purpose the various transformations are utilized. A second aspect of the geometric construction process is that graphics elements can be subtracted as well as added. Another way of saying this is that the model can be formed out of negative elements as well as positive elements.

Figure 2.14 illustrates this construction feature for a two-dimensional object, C. The object is drawn by subtracting circle B from rectangle A.

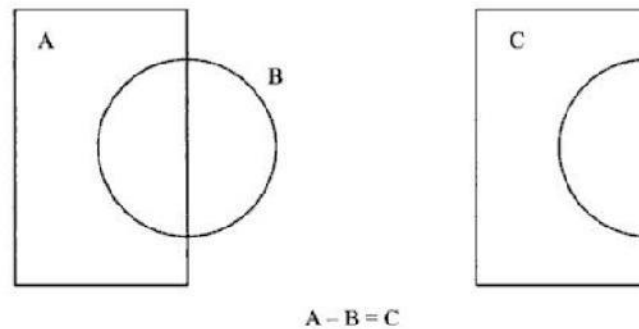

Figure 2.14 2D model construction by subtraction of Circle B from rectangle A

**(b) Defining the graphics elements**

The user has a variety of different ways to call a particular graphic element and position it on the geometric model. Table 2.2 lists several ways of defining points, lines, arcs, circles and other components of geometry through interaction with the ICG system. These components are maintained in the database in the mathematical form and referenced to a three-dimensional coordinate system. For example, a point would be defined simply by its  $x$ ,  $y$  and  $z$  coordinates.

A polygon would be defined as an ordered set of points representing the corners of the polygon. A circle would be defined by its centre and radius. Mathematically, a circle can be defined in the  $x, y$  plane by the equation:

$$(x-m)^2 + (y-n)^2 = r^2 \tag{1}$$

This specifies that the radius of the circle is  $r$  and the  $x$  and  $y$  of the centre are  $m$  and  $n$ . In each case, the mathematical definition can be converted into its corresponding edges and surfaces for filing in the database and display on the CRT screen.

---

Table 2.2 Methods of Defining Elements in Interactive Computer Graphics

---

*Points*

1. Pointing to the location on the screen by means of cursor control
2. Entering the coordinates via the alphanumeric keyboard
3. Entering the offset (distance in  $x$ ,  $y$  and  $z$ ) from a previously defined point
4. The intersection of two points
5. Locating points at fixed intervals along an element

*Lines*

1. Using two previously defined points
2. Using one point and specifying the angle of the line with the horizontal
3. Using a point and making the line either normal or tangent to a curve
4. Using a point and making the line either parallel or perpendicular to another point
5. Making the line tangent to two curves
6. Making the line tangent to a curve and parallel or perpendicular to a line

*Arcs and Circles*

1. Specifying the center and the radius.
  2. Specifying the center and a point on the circle
  3. Making the curve pass through three previously defined points
-

- 
4. Making the curve tangent to three lines
  5. Specifying the radius and making the curve tangent to two lines or curves

#### *Conics*

1. Specifying five points on the element
2. Specifying three points and a tangency condition

#### *Curves*

Mathematical splines are used to fit a curve through given data. For example, in a cubic spline, third-order polynomial segments are fitted between each pair of adjacent data points. Other curve generating techniques used in computer graphics include Bezier curves and B-spline methods. Both of these methods use a blending procedure which smoothens the effect of the data points. The resulting curve does not pass through all the points. In these cases the data points would be entered to the graphics system and the type of curve-fitting technique would be specified for determining the curve.

#### *Surfaces*

The methods described for generating curves can also be used for determining the mathematical definition of a surface. Automobile manufacturers use these methods to represent the sculptured surfaces of the sheet metal car body. Some of the methods for generating surfaces include:

1. Using a surface of revolution formed by rotating any lines and/or curves around a specific axis.
  2. Using the intersection line or surface of two intersecting surfaces. For example, this could be used to generate cross sections of parts, by slicing a plane through the part at the desired orientation.
- 

### **(c) Editing the geometry**

A computer-aided design system provides editing capabilities to make corrections and adjustments in the geometric model. When developing the model the user must be able to delete, move, copy and rotate components of the model. The editing procedure involves selecting the desired portion of the model (usually by means of one of the segmenting functions) and executing the appropriate command (often involving one of the transformation functions).

The method of selecting the segment of the model to be modified varies from system to system with cursor control, a common method is for a rectangle to be formed on the CRT screen around the model segment. The rectangle is defined by entering the upper left and lower right corners of the rectangle. Another method involving a light pen is to place the pen over the component to be selected with the electronic pen and tablet, the method might be to stroke a line across the portion of the model which is to be altered.

The computer must somehow indicate to the user which portion of the model has been selected. The reason for this is verification that the portion selected by the computer is what the user intended various techniques are used by different ICG systems to identify the segment. These include: placing a mark on the segment, making the segment brighter than the rest of the image and making the segment blink.

Some common editing capabilities available in commercial CAD systems are as follows:

1. *Move an item to another location.* This involves the translation of the item from one location to another.
2. *Duplicate an item at another location.* The copy function is similar to the move function except that it preserves a copy of the item at its original location.
3. *Rotate an item.* This is the rotation transformation, in which the item is rotated through a specified angle from its original orientation.
4. *Mirror an item.* This creates a mirror image of the item about a specified plane.
5. *Delete an item.* This function causes the selected segment of the model to be removed from the screen and from the database.
6. *Remove an item from the display* (without deleting it from the database). This removes the particular segment from the current image on the screen. However, it is not removed from the database. Therefore, repainting the screen from the database will cause the segment to reappear.
7. *Trim a line or other component.* This function would remove the portion of the line that extends beyond a certain point.
8. *Create a cell out of graphic elements.* This feature provides the capability to construct a cell cut of selected elements. The cell can then be added to the model in any orientation as needed.
9. *Scale an item.* A selected component can be scaled by a specified factor in  $x$ ,  $y$ , and  $z$  directions. The entire size of the model can be scaled, or it can be scaled in only one or two directions.

## 2.6.4 Transformations

### (a) Two Dimensional (2D)

#### (i) Translation

It is the most common and easily understood transformation in CAD. This moves a geometric entity in space in such a way that the new entity is parallel at all points to the old entity. A representation of an object is shown in Figure 2.15. Let us now consider a point on the object, represented by  $P$  which is translated along  $X$  and  $Y$  axes by  $dx$  and  $dy$  to a new position  $P'$ . The new coordinates after transformation are given by following equations.

$$P' = [x', y'] \quad (2)$$

$$x' = x + m \quad (3) \quad (3)$$

$$y' = y + n \quad (4) \quad (4)$$

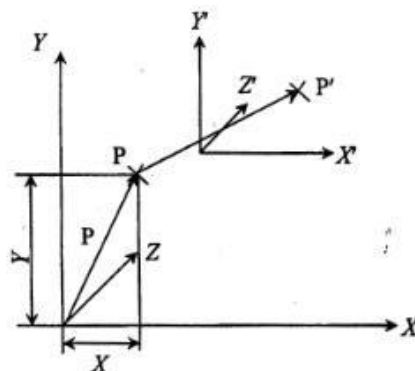

Figure 2.15 Translation of a point

Putting equations (3) & (4) back into equations (2);

$$P = \begin{bmatrix} x' \\ y' \end{bmatrix} = \begin{bmatrix} x+m \\ y+n \end{bmatrix} \quad (5)$$

$$P = \begin{bmatrix} x' \\ y' \end{bmatrix} = \begin{bmatrix} x+m \\ y+n \end{bmatrix} = \begin{bmatrix} x \\ y \end{bmatrix} + \begin{bmatrix} m \\ n \end{bmatrix} \quad (6)$$

In matrix notation this can be represented as;

$$(x') \Rightarrow x y + T \quad (7)$$

$$\text{Where, } T = (m)n \quad (8)$$

### (ii) Rotation

The final position and orientation of a geometric entity is decided by the angle of rotation ( $\theta$ ) and the base point about which the rotation is to be done (Figure 2.16). For a positive angle the rotation is counterclockwise.

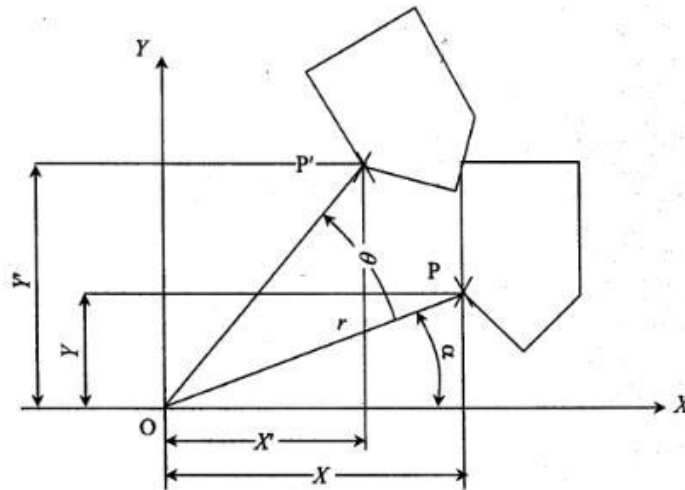

Figure 2.16 Rotation transformation

To develop the transformation matrix for transformation, consider a point P located in XY plane, being rotated in the counter clockwise direction to the new position, P' by an angle ( $\theta$ ) as shown in Figure 2.16. The new position P' is given by;

$$P' = [x', y']$$

From the following figure, the original position is specified by;

$$x = r \cos \alpha$$

$$y = r \sin \alpha$$

The new position, P' is specified by;

$$x' = r \cos(\alpha + \theta) = r \cos \alpha \cos \theta - r \sin \alpha \sin \theta \quad \theta \cos \alpha = x \sin \theta - y \quad \theta$$

$$y' = r \sin(\alpha + \theta) = r \sin \alpha \cos \theta + r \cos \alpha \sin \theta \quad \theta \sin \alpha = x \cos \theta + y \quad \theta$$

This can be written in matrix form as;

$$P' = \begin{bmatrix} x' \\ y' \end{bmatrix} = \begin{bmatrix} \cos \theta & -\sin \theta \\ \sin \theta & \cos \theta \end{bmatrix} \begin{bmatrix} x \\ y \end{bmatrix} \quad (9)$$

$$\text{Or, } P' = (x') y' R \text{ where R is the rotation matrix given by } \begin{bmatrix} \cos \theta & -\sin \theta \\ \sin \theta & \cos \theta \end{bmatrix}.$$

### (iii) Scaling

Scaling is the transformation applied to enlarge or reduce the size of an entity. The size is altered as per the by the scaling factor applied. For Example, in Figure 2.17, to achieve scaling, the original coordinates would be multiplied uniformly by the scaling factor.

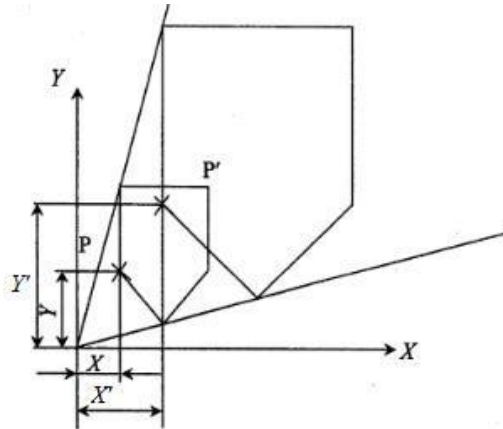

Figure 2.17 Scaling transformation

$$(x', y') = (x, y) S, \text{ where, } S \text{ is the scaling matrix given by } \begin{bmatrix} m & 0 \\ 0 & n \end{bmatrix}.$$

This would produce an alteration in the size of the element by the factor  $m$  in the  $x$ -direction and by the factor  $n$  in the  $y$ -direction. It has also the effect of repositioning the element with respect to the Cartesian system origin. If the scaling factors are less than 1, the size of the element is reduced and it moves closer to the origin. If the scaling factors are larger than 1, the element is enlarged and moves farther from the origin.

### (b) Three Dimensional (3D)

Transformations by matrix method can be extended to three-dimensional space. The notations are same as two-dimension case.

#### (i) Translation

The translation matrix for a point can be defined in three-dimension would be

$$T = (m, n, p)$$

and would be applied by adding the increments  $m, n$  and  $p$  to the respective coordinates of each of the points defining the three-dimensional geometry element.

#### (ii) Rotation

Rotation in three-dimension can be defined for each of the axes. Rotation about the  $z$  axis by an angle  $\theta$  is accomplished by the matrix

$$R_z = \begin{bmatrix} \cos\theta & -\sin\theta & 0 \\ \sin\theta & \cos\theta & 0 \\ 0 & 0 & 1 \end{bmatrix}$$

Rotation about the  $y$  axis by an angle  $\theta$  is accomplished similarly.

$$R_y = \begin{bmatrix} \cos\theta & 0 & \sin\theta \\ 0 & 1 & 0 \\ -\sin\theta & 0 & \cos\theta \end{bmatrix}$$

Rotation about the  $x$  axis by an angle  $\theta$  is accomplished by the following transform matrix.

$$R_x = \begin{bmatrix} 1 & 0 & 0 \\ 0 & \cos\theta & -\sin\theta \\ 0 & \sin\theta & \cos\theta \end{bmatrix}$$

### (iii) Scaling

The scaling transformation is given by;

$$S = \begin{bmatrix} m & 0 & 0 \\ 0 & n & 0 \\ 0 & 0 & p \end{bmatrix}$$

For equal value of  $m$ ,  $n$ , and  $p$  the scaling is linear.

### (c) Concatenation

Many a times it becomes necessary to combine the aforementioned individual transformations in order to achieve the required results. In such cases the combined transformation matrix can be obtained by multiplying the respective transformation matrices. However, care should be taken that the order of the matrix multiplication be done in the same way as that of the transformations as follows.

$$P' = [T_n [T_{n-1} [T_{n-2} ] \dots\dots [T_3 [T_2][T_1] \tag{10}$$

### (d) Homogeneous transformation

In order to concatenate the transformation as shown in equation (10), all the transformation matrices should be multiplicative type. However, as seen earlier, the translation matrix is vector additive, while all others are matrix multiplications. The following form should be used to convert the translation into a multiplication form.

$$P' = \begin{bmatrix} x' \\ y' \\ 1 \end{bmatrix} = \begin{bmatrix} 1 & 0 & m \\ 0 & 1 & n \\ 0 & 0 & 1 \end{bmatrix} \begin{bmatrix} x \\ y \\ 1 \end{bmatrix} \tag{11}$$

Hence the translation matrix in multiplication form can be given as

$$T = \begin{bmatrix} 1 & 0 & m \\ 0 & 1 & n \\ 0 & 0 & 1 \end{bmatrix} \tag{12}$$

This is termed as homogeneous representation. In homogeneous representation, an  $n$ -dimensional space is mapped into  $(n + 1)$  dimensional space. Thus a two dimensions point  $[x \ y]$  is represented in three dimensions as  $[x \ y \ 1]$ .

## 2.6.5 Wireframe model versus solid model

### (a) Wireframe Model

Wireframe modeling is one of the methods used in geometric modelling. A wireframe model represents the shape of a solid object with its characteristic lines and points, there is no skin defining the area between the edges. The model contains information about the locations of all the points (vertices) and edges in space coordinates. Each vertex is defined by  $x$ ,  $y$ ,  $z$  coordinates. Edges are defined by a pair of vertices. Faces are defined as three or more edges. The model consists entirely of points, lines, arcs and circles, conics, and curves. The word “wireframe” is related to the fact that one may imagine a wire that is bent to follow the object edges to generate a model.



### Methods for creating 3D wireframe

1. Extrusion is a technique for creating a 3D wire-frame model by copying a 2D profile and extending it to a depth defined by the operator. The result is a 3D wireframe of the profile.
2. Rotation produces wire-frame models by rotating a cross section or profile of the part about an axis. It is similar to extrusion except it is swept about an axis.
3. Extrusion with scale technique consists of defining the depth along with the facility of enlarging scale uniformly.
4. Using primitive shapes to build models.

### Advantages of Wireframe model:

1. Simple to construct, retrieving and editing can be done easily.
2. Designer needs little training.
3. System needs little memory and also take less manipulation time.
4. Best suitable for manipulations as orthographic isometric and perspective views and quickly and efficiently convey information than multi-view drawings.
5. Can be used for finite element analysis.
6. Can be used as input for CNC machines to generate simple parts.
7. Contain most of the information needed to create surface, solid and higher order models.

### Disadvantages of Wireframe model:

1. Image causes confusion.
2. Cannot get required information from this model.
3. Hidden line removal features not available.
4. Not possible for volume and mass calculation, NC programming cross sectioning etc.
5. Not suitable to represent complex surfaces and solids.
6. Do not represent an actual solids (no surface and volume).
7. Cannot be used to calculate dynamic properties

### (b) Solid Model

An improvement over wire-frame models, both in terms of realism to the user and definition to the computer, is the solid modeling approach. In this approach, the models are displayed as solid objects to the viewer, with very little risk of misinterpretation. A solid model can be used to analyze the moment of inertia, mass, volume, sections of the model, etc. Solid models are mathematical models of objects in the real world that satisfy specific properties, listed below.

1. **Bounded:** The boundary must limit and contain the interior of the solid.
2. **Homogeneously Three-Dimensional:** No dangling edges or faces be present so that the boundary is always in contact with the interior of the solid.
3. **Finite:** The solid must be finite in size.

In engineering, a solid model is used for the following applications:

1. **Graphics:** generating drawings, surface and solid models
2. **Design:** Mass property calculation, interference analysis, finite element modeling, kinematics and mechanism analysis, animation, etc.
3. **Manufacturing:** Tool path generation and verification, process planning, dimension inspection, tolerance and surface finish.

4. **Component Assembly:** Application to robotics and flexible manufacturing: Assembly planning, vision algorithm, kinematics and dynamics driven by solid models.

A solid model can be generated by the following schemes.

- (a) Constructive Solid Geometry (CSG)
- (b) Boundary Representation (B-Rep)
- (c) Sweeping

**(a) Constructive Solid Geometry (CSG)**

Constructive solid geometry (CSG) is often referred to as a building block approach, the building blocks in question being the higher-level graphics primitives bases on the rules of Boolean operations. The operators commonly used are union ( $\cup$ ), difference ( $-$ ), and intersection ( $\cap$ ). The union operator joins two primitives; thus, the union of the cylinder with the plate B creates the vane in Figure 2.18(a). The difference operator subtracts one primitive from the other, thus  $A-B$  yields the fork shown in Figure 2.18(b). In other words,  $A - B = (\text{Volume of object A}) - (\text{Volume common to A and B})$ .

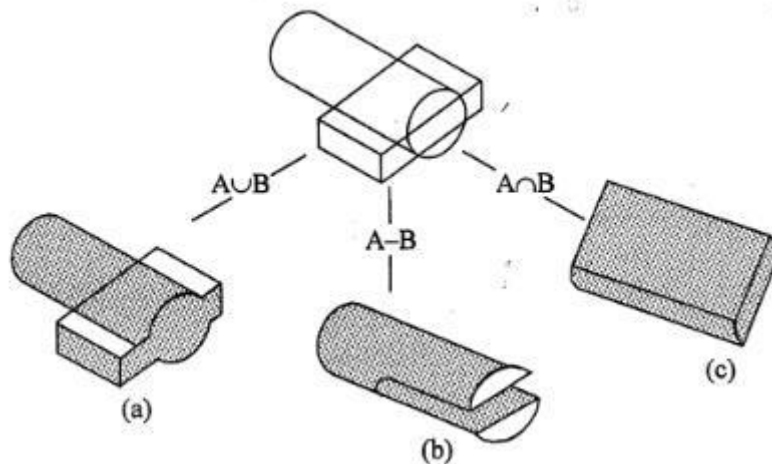

Figure 2.18 Constructive solid geometry

The intersection operator eliminates all parts of the primitives except the regions that are common to both; thus  $A \cap B$  results in the piece shown in Figure 2.18(c). As a first step towards modeling, appropriate primitive are selected from the menu. A typical assortment of primitive is shown in Figure 2.19. The primitives are then subjected to some unary operations such as, scaling, rotating, translating and mirroring. Two or more of the primitives thus created are then operated on to form a new primitive.

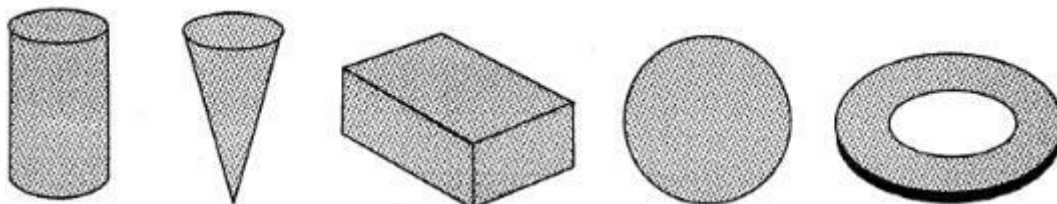

Figure 2.19 CAD primitives

Since CSG uses solid primitives, internal details of the object are automatically contained in the model. These models can be sanctioned to study internal details and may be used for calculating mass, volume, moment of inertia etc. The drawback of this modeling scheme is the limited number of pattern primitive and available to the user. CATIA (DS) and UNISOLIDS (McDonnell Douglas) are examples of CSG based solid modelers.

One of the main problems of set-theoretic modelling (CSG) is in achieving the efficient calculation of the intersections between the elements of the model. For complex models with many instances of primitives this can be very computationally intensive. The intensity of this task may be reduced by such means as spatial division of the model such that intersections are only tested for primitives in proximity to each other.

### (b) Boundary Representation (B-Rep)

This scheme is based on the concept that a physical object is bounded by a set of faces. A solid model is created by combining faces and contains vertices, edges, loops, and bodies. Only the boundary surfaces of the model are stored and the volumetric properties are calculated by the Gauss Divergence theorem, which relates volume integral to surface integrals. This scheme can model a variety of solids depending on the primitive surfaces (planar, curved, or sculptured). There are two types of solid models in this scheme:

1. Polyhedral solids
2. Curved solids

**1. Polyhedral Solids:** Polyhedral models consist of straight edges, e.g., a non-cylindrical surface: box, wedge, combination of two or more non-cylindrical bodies, etc. Polyhedral solids can have blind or through holes, and two or three-dimensional faces, with no dangling edges. A valid polyhedral abides by the Euler's equation:

$$F - E + V - L = 2 \quad (\text{B-G})$$

Where,

- F = Face
- E = Edge
- V = Vertices
- L = Inner Loop
- B = Bodies
- G = Through holes

A simple polyhedral has no holes; each face is bounded by a single set of connected edges (bounded by one loop of edges). Euler's equation for a simple polyhedral can be reduced to:  $F - E + V = 2$

Example: For the box shown,  $F = 6$ ,  $E = 12$ , and  $V = 8$

Examples of other types of polyhedral are shown below.

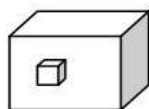
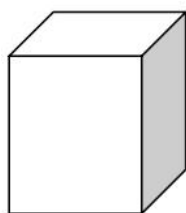

*Polyhedral with two loops*

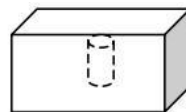

*Polyhedral with a blind hole*

**2. Curved Solids:** A curved solid is similar to a polyhedral object but it has curved faces and edges. Spheres and cylinders are examples of curved solids.

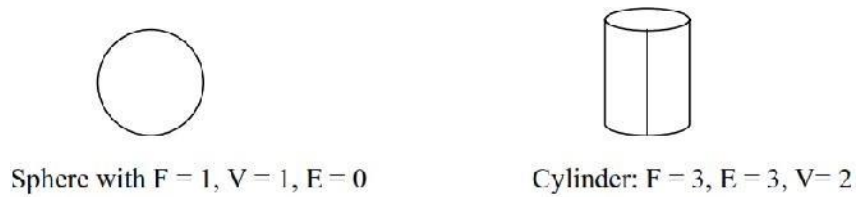

**Primitives:** In B-rep, a model is made up of the following primitives:

- **Vertex:** A point in space
- **Edge:** A finite, no-intersecting space curve bounded by two vertices that are not necessarily distinct.
- **Face:** A finite connected, non-self-intersecting, region of a closed oriented surface, bounded by one or more loops.
- **Loop:** An ordered alternating sequence of vertices and edges. A loop defines a non-self-intersecting closed space curve, which may be a boundary of a face.
- **Body:** Entity that has faces, edges and vertices. A minimum body is a point.

**(c) Sweeping**

Sweeping can create a solid model. The method is useful for creating 2 ½-dimension models. The generated models are axisymmetric and have uniform thickness (i.e., extruded models). There are two types of sweeps: linear and rotational. In linear sweep, a closed 2-D sketch is extruded through the desired length, creating a homogeneous and axisymmetric model, as shown in the Figure 2.20. In rotational sweep, a closed sketch is rotated around an axis. The generated model is always axisymmetric.

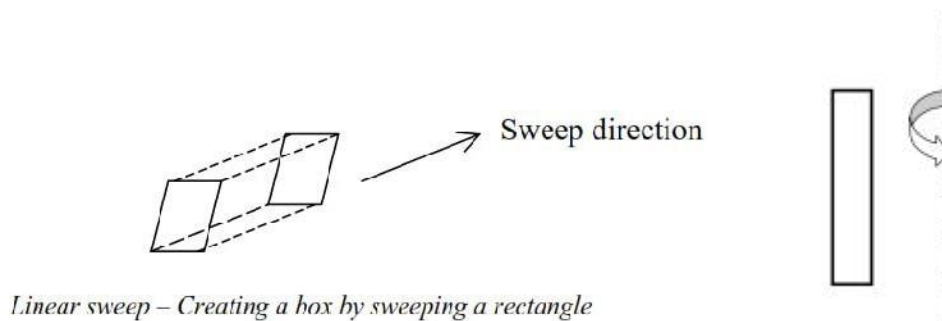

Figure 2.20 Sweeping scheme

In addition to the two sweeps described above, a model can also be created by a nonlinear sweep. In this type of sweep, a closed sketch is swept along a non-linear path.

## 2.7 GRAPHICS STANDARDS

CAD/CAM software may be perceived as an application program supported by a graphics system as shown in Figure 2.21. The graphics system performs all related graphics techniques. In the actual source code of the application program, the graphics system is embedded in the form of subroutine calls. Therefore, software becomes inevitably device-dependent. If input/output devices change or become obsolete, its related software becomes obsolete as well unless significant resources are dedicated to modify such software. This approach was very costly to both CAD/CAM vendors as well as users.

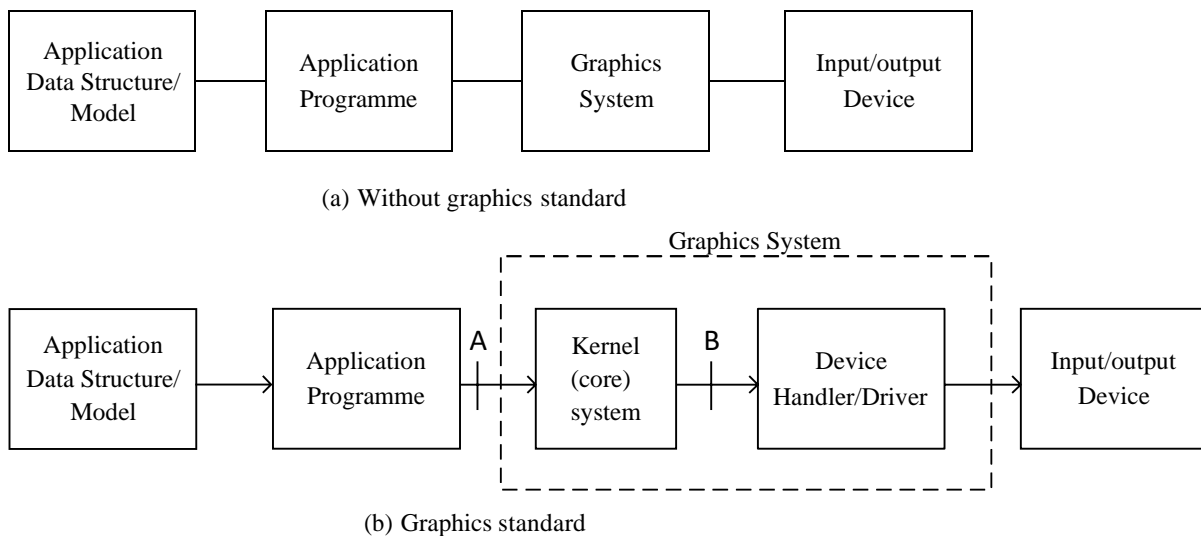

Figure 2.21 Organization of a typical CAD/CAM Software

The needs for graphics standards were obvious and were acknowledged by the CAD/CAM community-both vendors and users. The following are some of these needs:

1. **Application program portability.** This avoids hardware dependence of the program. For example, if the program is written originally for a DVST display, it can be transported to support it raster display with minimal effort.
2. **Picture data portability.** Description and storage of pictures should be independent of different graphics devices.
3. **Text portability.** This ensures that text associated with graphics can be presented in an independent form of hardware.
4. **Object database portability.** While the above needs concern CAD/CAM vendors, transporting design and manufacturing (product specification) data from one system to another is of interest to CAD/CAM users. In some cases, a company might need to ship a CAD database of a specific design to an outside vendor to manufacture and produce the product.

With the above needs in mind, the search for standards began in 1974 and the GSPC (Graphics Standards Planning Committee) was formed to address the standards issue. The focus of standards is that the application program should be device-independent and should interface to any input device through a device handler and to any graphics display through a device driver. This leads to the conceptual organization of CAD/CAM software as shown in Figure 2.21.

The graphics system is divided into two parts: the kernel, (core) system, which is hardware-independent and the. Device handler/driver, which is naturally hardware-dependent. The kernel system, therefore, acts as a buffer between the application program and the specific hardware to ensure the independence and portability of the program. At interface A in the figure, the application program calls the standard functions and subroutines provided by the kernel system through what is called language bindings. These functions and subroutines, in turn, call the device handler/driver functions and subroutines at interface B to complete the task required by the application program.

CAD/CAM software can now serve several hardware generations. It is also portable from one graphics system to another. Application and system programmers also become portable and can move from one system to another. Moreover, if a device becomes obsolete or a new one is to be supported, only the device handler/driver is to be written or modified. This is possible because the kernel system works with virtual devices.

The search for standards that began in 1974 continued both at the USA and international levels. In 1977 and 1979 the ACM (Association for Computing Machinery) SigGraph group published two landmark reports (not formal standard) on the core system. Core was never standards but influenced many related efforts. In 1981 the GSPC disbanded and the ANSI (American National Standards Institute) has formed the Technical Committee on Computer Graphics Languages, X3H3, to produce a standardized core of device-independent computer graphics functions. At the international level, similar efforts to that of the GSPC were directed by the ISO (International Standards Organization). The technical work was led by the German Standards Institute (GIN) and resulted in the GKS (Graphics Kernel System). GKS has been adopted by the USA with the ANSI version having four output levels instead of three.

As a result of these worldwide efforts, various standards functioning at various levels of the graphics system shown in Figure 2.21 exist. These are:

1. **GKS** is an ANSI and ISO standard. It is device-independent, host-system independent and application-independent. It supports both two-dimensional and three-dimensional data and viewing. It interfaces the application program with the graphics support package.
2. **PHIGS** (Programmer's Hierarchical Interactive Graphics System) is intended to support high function workstations and their related CAD/CAM applications. The significant extensions it offers beyond GKS-3D are in supporting segmentation used to display graphics and the dynamic ability to modify segment contents and relations hips. PHIGS operates at the same level as GKS (interface A).
3. **VDM** (Virtual Device Metafile) defines the functions needed to describe a picture. Such description can be stored or transmitted from one graphics device to another. It functions at the level just above device drivers. VDM is now called CGM (Computer Graphics Metafile).
4. **VDI** (Virtual Device Interface) lies between GKS or PHIGS and the device handler/driver code (interface B in Fig. 3.2*h*). Thus VDI is the lowest device independent interface in a graphics system. It shares many characteristics with CGM. VDI is designed to interface plotters to GKS or PHIGS. It is not suitable to interface intelligent workstations. It is also not well matched to a distributed or network environment. VDI is now called CGI (Computer Graphics Interface).

5. **IGES** (Initial Graphics Exchange Specification) was approved in September 1981 as the ANSI Standard Y14.26M. It enables an exchange of model data bases among CAD/CAM systems. IGES functions at the level of the object database or application data structure.
6. **NAPLPS** (North American Presentation-Level Protocol Syntax) was accepted by Canada and ANSI in 1983. It describes text and graphics in the form of sequences of bytes in ASCII code.

Various CAD/CAM users and application or system programmers may be interested in one or more of the above standards. Awareness of these standards can be used as a guideline in evaluating various CAD/CAM systems. For example, mechanical design requires three-dimensional modeling. Therefore, a system that supports GKS-3D or PHIGS is required. However, for two-dimensional applications such as VLSI design, GKS-2D is adequate. In addition, the future needs of the system must also be considered to avoid locking the system into software that will be unnecessarily difficult to upgrade over the coming years. Finally, knowledge of these standards and their functions might stimulate engineers to think of developing design and manufacturing standards, through engineering organizations and enforce them on CAD/CAM vendors.

## **2.8 DATABASE STRUCTURE AND CONTENT**

### **2.8.1 Data Structure**

Formally a data structure is defined as a set of data items or elements that are related to each other by a set of relations. Applying these relations to the elements of the set results in a meaningful object. From a CAD/CAM point of view, a data structure is a scheme, logic, or a sequence of steps developed to achieve a certain graphics, non-graphics and/or a programming goal.

As an example consider the object shown in Figure 2.22. Three different types of data structures have been identified to construct the object. They are based on edges, vertices, or blocks. Within the context of the above formal definition of a data structure, the set of edges, vertices, or blocks is the set of data items for each type and edges, vertices, or blocks are the data items themselves. Furthermore, the connectivity vertices for the first type, the edge information for the second and the set operators for the third form the set of relations required by each type. As an example, 1, A & B in Figure 2.22 (b) indicates that vertex 1 is shared by edges A and B while in Figure 2.22(c) A, 1& 4 indicates that edge A has the two vertices 1 and 4.

### **2.8.2 Database**

The term "database" is commonly used and may mean different things to different users. Casually, it is synonymous with the terms "files" and "collection of files." Formally, a database is defined as an organized collection of graphics and non-graphics data stored on secondary storage in the computer. It could, therefore, be viewed as the art of storing or the implementation of data structure into the computer. Hence, it is a repository for stored data. From a software development point of view, a decision on the data structure has to be made first, followed by a choice of a database to implement such a structure. There may exist more than one alternative of database to implement a given data structure.

The objective of a database is to collect and maintain data in a central storage so that it will be available for operations and decision-making. The advantages that accrue from having centralized control of the data, or a centralized database, is manifold:

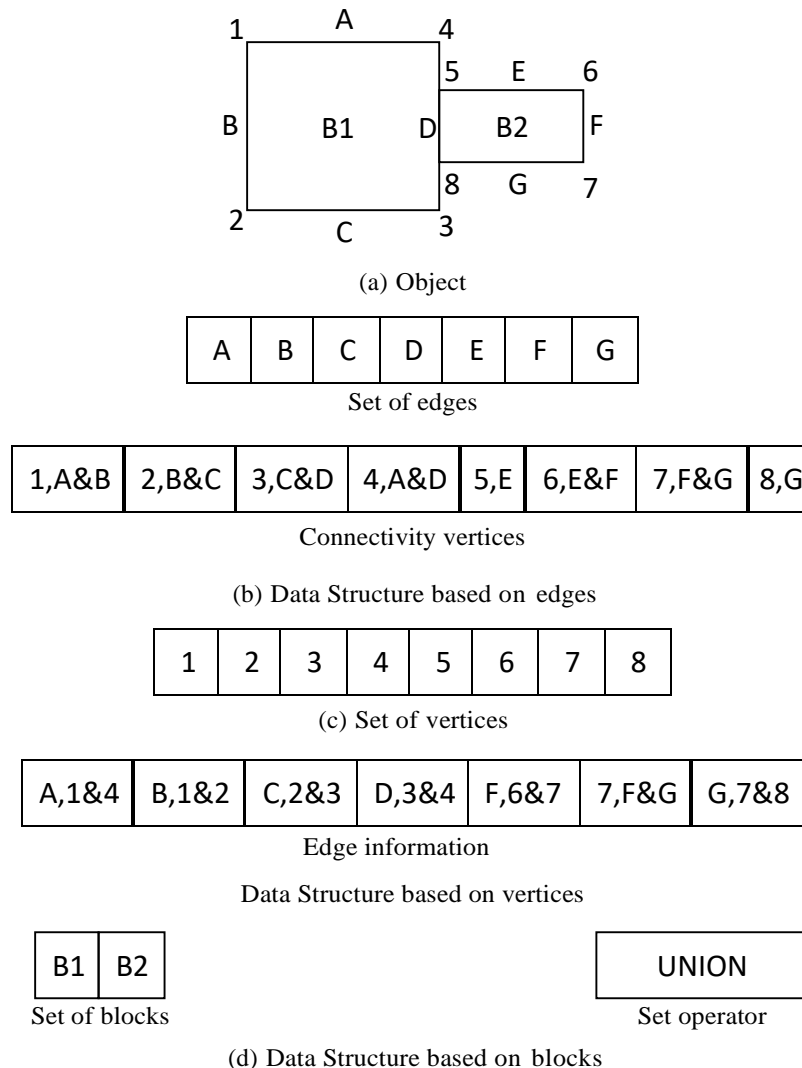

Figure 2.22 Various data structures of an object

1. **Eliminate Redundancy.** This is important for integrated CAD/CAM functions and CIM applications. The database should be rich enough to support all various phases of product design and manufacturing. If both design and manufacturing departments, for example, have access to the same database, inconsistent and conflicting decisions are inherently eliminated and data is shared by all applications. Thus, engineering assets and experiences of a company can be captured in a database and modified for new product designs.
2. **Enforce Standards.** With central control of the database, both national and international standards are followed. Dimensioning and tolerancing are examples. In addition, a company can develop its own internal standards required by various departments. Standards are desirable for data interchange or migration between systems.



3. **Apply Security Restrictions.** Access to sensitive data and projects can be checked and controlled by assigning each user the proper access code (read, write, delete, copy and/or none) to various parts of the database.
4. **Maintain Integrity.** The integrity of the database ensures its accuracy, Integrity precedes consistency. Lack of database integrity can result in inputting inconsistent data.
5. **Balance Conflicting Requirements.** Compromises can easily be when designing a model of the centralized database to provide its overall best performance. If, for example, a software is designed solely for design and modeling, one would expect inadequate performance in manufacturing functions.

### 2.8.2 Database models

CAD/CAM databases must be able to store pictorial data in addition to and alphanumeric data typically stored in conventional databases. A brief description of the popular database models is provided below:

1. **Relational Database.** Data is stored in tables, called relations that related to each other. The relations are stored in files which can be accessed sequentially or in a random access mode. Sequential access files are widely used. As an example, the relations needed to describe the object in Figure 2.22 are shown in Figure 2.23. The object is represented by the three relations POINT, LINE/CURVE and SURFACE. A particular data structure shown in Figure 2.22 determines which relations are to be entered by the user and which are be calculated automatically. One of the disadvantages of the database is that it requires substantial sorting, which might result in the system response to user commands.

Point	x	y
1	x <sub>1</sub>	y <sub>1</sub>
2	x <sub>2</sub>	y <sub>2</sub>
3	x <sub>3</sub>	y <sub>3</sub>
4	x <sub>4</sub>	y <sub>4</sub>
5	x <sub>5</sub>	y <sub>5</sub>
6	x <sub>6</sub>	y <sub>6</sub>
7	x <sub>7</sub>	y <sub>7</sub>
8	x <sub>8</sub>	y <sub>8</sub>

Relation POINT

Line	Start Point	End Point
A	1	4
B	1	2
C	2	3
D	3	4
E	5	6
F	7	7
G	7	8

Relation LINE/CURVE

Surface	Line/Curve	Type
1	A	Line
	B	Line
	C	Line
	D	Line
2	E	Line
	F	Line
	G	Line
	D	Line

Relation SURFACE

Figure 2.23 Relational database of object shown in figure 2.22

2. **Hierarchical Database.** In this model, data is represented by a structure. The top of the tree is usually known as the "root" and the superior for hierarchy, of the tree levels relative to each other descends from the down. Figure 2.24 shows a hierarchical database of the object shown in Figure 2.22. Four levels are required to represent the object completely. One of drawbacks of the hierarchical approach is the asymmetry of the tree which forces database programmers to devote time and effort to problems, introduced by the hierarchical approach, which are not to the object modeling itself.

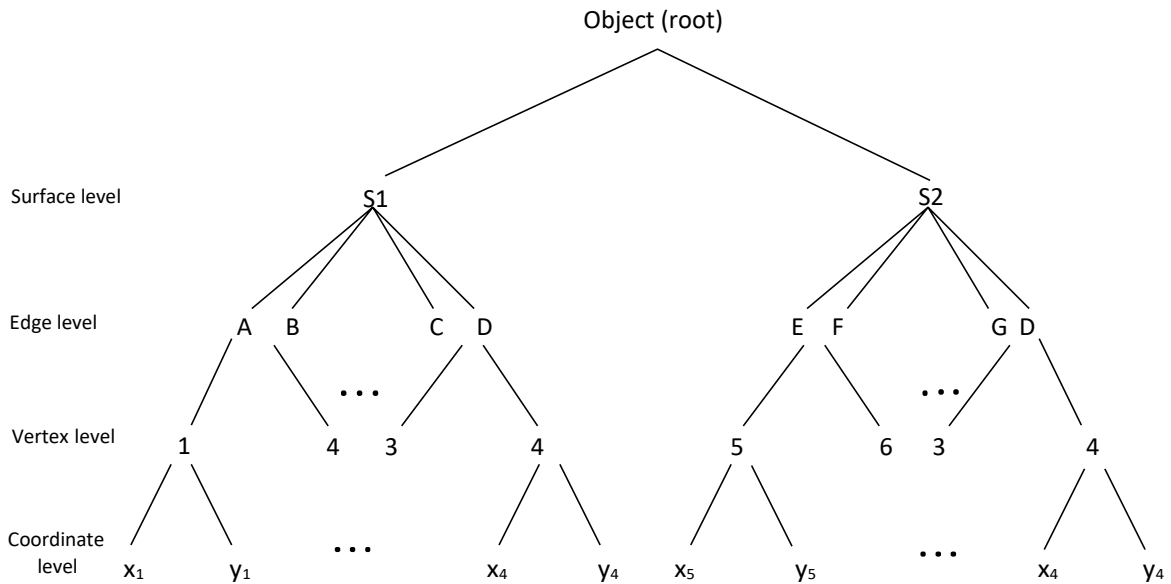

Figure 2.24 Hierarchical database of object shown in figure 2.22

3. **Network Database.** The network approach permits modeling of many-to-many correspondence more directly than the hierarchical approaches. Figure 2.25 shows a network database of the object shown in Figure 2.22. The prime disadvantage of the network approach is its undue complexity both in the database structure itself and in the associated programming of it.

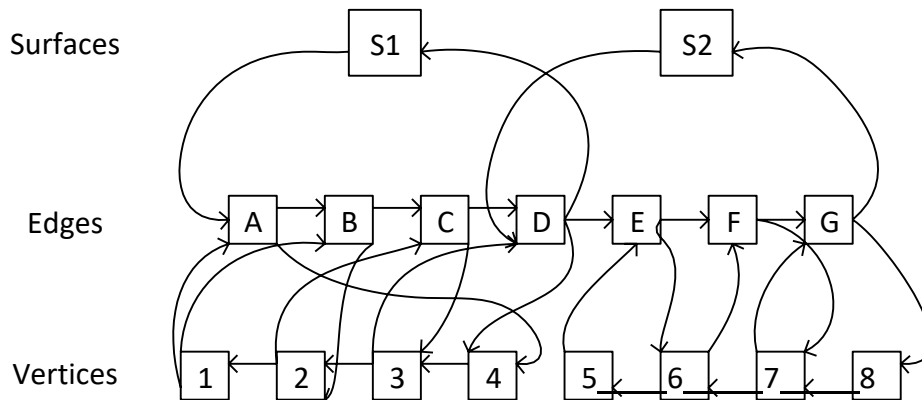

Figure 2.25 Network database of object shown in figure 2.22

4. **Object oriented Database.** Unlike conventional database processing, CAD/CAM applications require object-oriented accessing and manipulation; that is, units of retrieval and storage are design objects and not individual records in files. These design objects also form the basis for ensuring database integrity upon the insertion, deletion, or modification of component objects. The object-oriented model should be able to capture all the relevant semantics of objects. This, in turn, results in a "rich," well-integrated and complete database readily accessible for applications. Object-

oriented database models include the entity relationship model, complex object representation, molecular object representation and abstract data model. The abstract data model is close to solid modeling databases. It employs abstract objects as primitives in the design of the database. Figure 2.26 shows an example of this database. Primitives are constructed from input data and form the lowest field or record of storage in the database.

Sub-object B1                      Object                      Sub-object B2

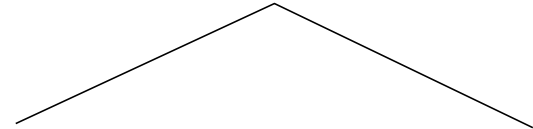

Figure 2.26 Object-oriented Database of object Shown in figure 2.22

Object-oriented databases seem to be ideal for CAD/CAM applications. Hybrid database models may also be useful. The following are some of the functional requirements and specifications that CAD/CAM databases must support:

1. Multiple engineering applications from conceptual design to manufacturing operations.
2. Dynamic modification and extension of the database and its associativity.
3. The iterative nature of design. This nature is not common in business data processing. CAD/CAM database management systems must support the tentative, iterative and evolutionary nature of the design process.
4. Design versions and levels of detail. CAD databases must provide a capability for storage and management of multiple design solutions that may exist for a particular design. There is seldom a unique solution to a design problem and there may exist several optimal solutions.
5. Concurrent and multiple users must be supported from the database. Large design projects usually involve multiple designers working simultaneously on multiple aspects of a project.
6. Temporary database support. Due to the iterative nature of design, earlier generated data may not be committed to the database until the design process is completed.
7. Free design sequence. The database system should not impose constraints on the designer to follow because different designs require different sequences.
8. Easy access. Application programs requiring data from a CAD/CAM database should not require extensive knowledge of the database structure to extract the data needed. This is important in customizing CAD/CAM systems for specific design and manufacturing procedures.

### 30 NUMERICAL CONTROL

### MODULE-III

Numerical control can be defined as a form of programmable automation in which the process is controlled by numbers, letters, and symbols. In NC, instruction program changes when the workpart changes without making appreciable changes in the production equipment. This capability to change the program for each new job is what gives NC its flexibility. Numerical control should be considered as a possible mode of controlling the operation for any production situation possessing the following characteristics:

- Similar workparts in terms of raw material (e.g. metal stock for machining)
- The work parts are produced in various sizes and geometries.
- The workparts are produced in batches of small to medium size quantities.
- A sequence of similar processing steps is required to complete the operation on each workpiece.

NC technology has been applied to a wide variety of operations, including drafting, assembly, inspection, sheet metal press working, and spot welding. However, numerical control finds its principal applications in metal machining processes. The machined workparts are designed in various sizes and shapes and also in small to medium batches. To produce each part, a sequence of machining operations may be required.

### 31 COMPONENTS OF AN NC SYSTEM

An operational numerical control system consists of the following three basic components:

1. Program of instructions
2. Controller unit, also called a machine control unit (MCU)
3. Machine tool or other controlled process

The general relationship among the three components is illustrated in Figure 3.1.

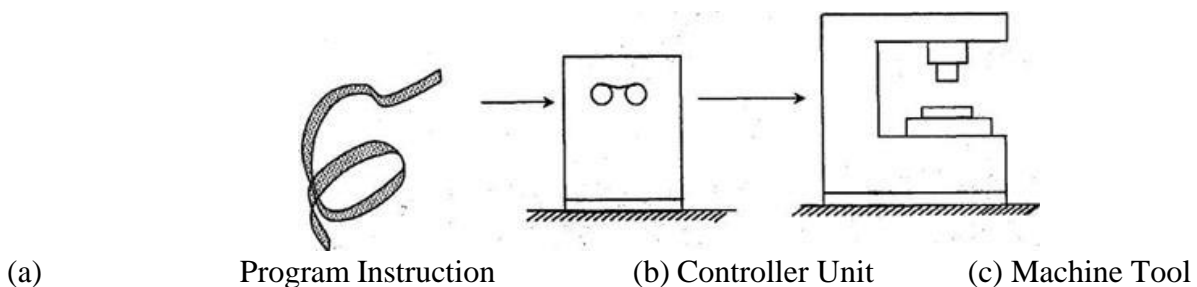

Figure 3.1 Components of an NC System

The program of instructions serves as the input to the controller unit, which in turn commands the machine tool or other process to be controlled.

#### Program of Instructions

The program of instructions is the detailed step-by-step set of directions which tell the machine tool what to do. It is coded in numerical or symbolic form on some type of input medium that can be interpreted by the controller unit. The most common input medium today is 1-in-wide punched tape. Over the years, other forms of input media have been used, including punched cards, magnetic tape, and even 35-mm motion picture film.

There are two methods of input to the NC system. The first is by manual entry of instructional data to the controller unit. This method is called manual data input, abbreviated

MDI, and is appropriate only for relatively simple jobs where the order will not be repeated. The second other method of input is by means of a direct link with a computer. This is called direct numerical control, or DNC.

### **Controller Unit**

The second basic component of the NC system is the controller unit. This consists of the electronics and hardware that read and interpret the program of instructions and convert into mechanical actions of the machine tool. The typical elements of a conventional NC controller unit include the tape reader, a data buffer, signal output channels to the machine tool, feedback channels from the machine tool, and the sequence controls to coordinate the overall operation of the foregoing elements. It should be noted that nearly all modern NC systems today are sold with a microcomputer as the controller unit. This type of NC is called computer numerical control (CNC).

The tape reader is an electromechanical device for winding and reading the punched tape containing the program of instructions. The data contained on the tape are read into the data buffer. The purpose of this device is to store the input instructions in logical blocks of information. A block of information usually represents one complete step in the sequence of processing elements. For example, one block may be the data required to move the machine table to a certain position and drill a hole at that location.

The signal output channels are connected to the servomotors and other controls in the machine tool. Through these channels, the instructions are sent to the machine tool from the controller unit. To make certain create the instructions have been properly executed by the machine, feedback data are sent back to the controller via the feedback channels. The most important function of this return loop is to assure that the table and workpart have been properly located with respect to the tool.

Sequence controls coordinate the activities of the other elements of the controller unit. The tape reader is actuated to read data into the buffer from the tape, signals are sent to and from the machine tool, and so on. These types of operations must be synchronized and this is the function of the sequence controls.

Another element of the NC system, which may be physically part of the controller unit or part of the machine tool, is the control panel. The control panel or control console contains the dials and switches by which the machine operator runs the NC system. It may also contain data displays to provide information to the operator. Although the NC system is an automatic system, the human operator is still needed to turn the machine on and off, to change tools (some NC systems have automatic tool changers), to load and unload the machine, and to perform various other duties. To be able to discharge these duties, the operator must be able to control the system, and this is done through the control panel.

### **Machine tool or other controlled process**

The third basic component of an NC system is the machine tool or other controlled process. It is part of the NC system which performs useful work. In the most common example of an NC system, one designed to perform machining operations, the machine tool consists of the worktable and spindle as well as the motors and controls necessary to drive them. It also includes the cutting tools, work fixtures, and other auxiliary equipment needed in the machining operation.

NC machines range in complexity from simple tape-controlled drill presses to highly sophisticated and versatile machining centers. It is a multifunction machine which incorporates several time saving features into a single piece of automated production equipment. First, a machining center is capable of performing a variety of different operations: drilling, tapping, reaming, milling, and boring. Second, it has the capacity to change tools automatically under tape command. A variety of machining operations means that a variety of cutting tools are required. The tools are kept in a tool drum or other holding device. When the tape calls a particular tool, the drum rotates to position the tool for insertion into the spindle. The automatic tool changer then grasps the tool and places it into the spindle chuck. A third capability of the NC machining center is workpiece positioning. The machine table can orient the job so that it can be machined on several surfaces, as required. Finally, a fourth feature possessed by some machining centers is the presence of two tables or pallets on which the workpiece can be fixtured. While the machining sequence is being performed on one workpart, the operator can be unloading the previously completed piece, and loading the next one. This improves machine tool utilization because the machine does not have to stand idle during loading and unloading of the workparts.

### 32 THE NC PROCEDURE

To utilize numerical control in manufacturing, the following steps must be accomplished.

1. **Process planning.** The engineering drawing of the workpart must be interpreted in terms of the manufacturing processes to be used. This step is referred to as process planning and it is concerned with the preparation of a route sheet. The route sheet is a listing of the sequence of operations which must be performed on the workpart. It is called a route sheet because it also lists the machines through which the part must be routed in order to accomplish the sequence of operations. We assume that some of the operations will be performed on one or more NC machines.
2. **Part programming.** A part programmer plans the process for the portions of the job to be accomplished by NC. Part programmers are knowledgeable about the machining process and they have been trained to program for numerical control. They are responsible for planning the sequence of machining steps to be performed by NC and to document these in a special format. There are two ways to program for NC:

Manual part programming

Computer-assisted part programming

In manual part programming, the machining instructions are prepared on a form called a part program manuscript. The manuscript is a listing of the relative cutter/workpiece positions which must be followed to machine the part. In computer-assisted part programming, much of the tedious computational work required in manual part programming is transferred to the computer. This is especially appropriate for complex workpiece geometries and jobs with many machining steps. Use of the computer in these situations results in significant savings in part programming time.

3. **Tape Preparation.** A punched tape is prepared from the part programmer's NC process plan. In manual part programming, the punched tape is prepared directly from the part program manuscript on a typewriter like device equipped with tape punching capability, In computer-assisted part programming, the computer interprets the list of part programming instruction, performs the necessary calculations to convert this into a detailed set of machine tool motion command, and then controls a tape punch device to prepare the tape for the specific NC machine.

4. **Tape verification.** After the punched tape has been prepared, a method is usually provided for checking the accuracy of the tape. Sometimes the tape is checked by running it through a computer program which plots the various tool movements (or table movements) on paper. In this way, major error in the tape can be discovered. The "acid test" of the tape involves trying it out on the machine tool to make the part. A foam or plastic material is sometimes used off this tryout.
5. **Production.** The final step in the NC procedure is to use the NC tape in production. This involves ordering the raw work parts, specifying and preparing the tooling and any special fixturing that may be required and setting up the NC machine tool for the job. The machine tool operator's function during production is to load the raw workpart in the machine and establish the starting position of the cutting tool relative to the workpiece. The NC system then takes over and machines the parts according to the instructions tape. When the part is completed, the operator removes it from the machine and loads the next part.

### 33 NC COORDINATE SYSTEMS

In order for the part programmer to plan the sequence of positions and movements of the cutting tool relative to the workpiece, it is necessary to establish a standard axis system by which the relative positions can be specified. Using an NC drill press as an example, the drill spindle is in a fixed vertical position, and the table is moved and controlled relative to the spindle. However, to make things easier for the programmer, we adopt the viewpoint that the workpiece is stationary while the drill bit is moved relative to it. Accordingly, the coordinate system of axes is established with respect to the machine table.

Two axes,  $x$  and  $y$ , are defined in the plane of the table, as shown in Figure 4.2. The  $z$ -axis is perpendicular to this plane and movement in the  $z$  direction is controlled by the vertical motion of the spindle. The positive and negative directions of motion of tool relative to table along these axes are as shown in figure. NC drill presses are classified as either two-axis or three-axis machines, depending on whether or not they have the capability to control the  $z$ -axis.

A numerical control milling machine and similar machine tools (boring mill, for example) use an axis system similar to that of the drill press. However, in addition to the three linear axes, these machines may possess the capacity to control one or more rotational axes.

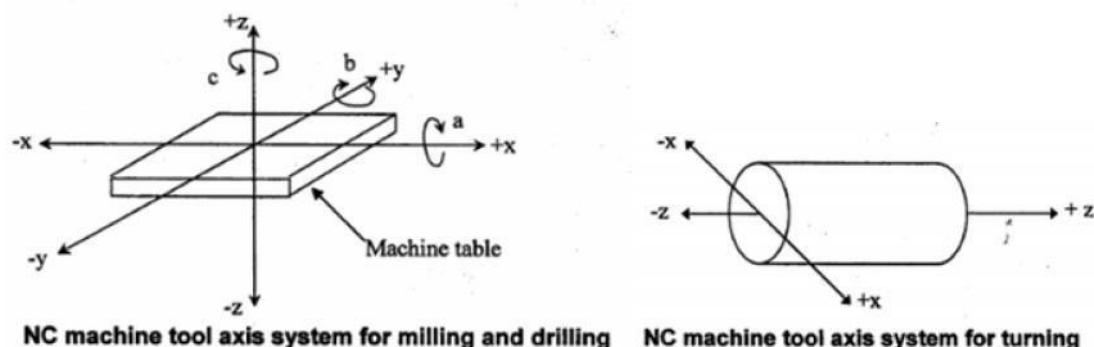

Figure 3.2 NC Coordinate System

Three rotational axes are defined in NC: the  $a$ ,  $b$ , and  $c$  axes. These axes specify angles about the  $x$ ,  $y$ , and  $z$  axes, respectively. To distinguish positive from negative angular motions, the "right-hand rule" can be used. Using the right hand with the thumb pointing in the positive

linear axis direction (x, y, or z), the fingers of the hand are curled to point in the positive rotational direction.

For turning operations, two axes are normally all that are required to command the movement of the tool relative to the rotating workpiece; the z axis is the axis of rotation of the workpart, and x axis defines the radial location of the cutting tool. This arrangement is illustrated in figure.

The purpose of the coordinate system is to provide a means of locating the tool in relation to the workpiece. Depending on the NC machine, the part programmer may have several different options available for specifying this location.

### **Fixed Zero and floating zero**

The programmer must determine the position of the tool relative to the origin (zero point) of the coordinate system. NC machines have either of two methods for specifying the zero point. The first possibility is for the machine to have a fixed zero. In this case, the origin is always located at the same position on the machine table. Usually, that position is the southwest corner (lower left-hand corner) of the table and all tool locations will be defined by positive x and y coordinates.

The second and more common feature on modern NC machines allows the machine operator to set the zero point at any position on the machine table. This feature is called floating zero. The part programmer is the one who decides where the zero point should be located. The decision is based on part programming convenience. For example, the workpart may be symmetrical and the zero point should be established at the center of symmetry. The location of the zero point is communicated to the machine operator. At the beginning of the job, the operator moves the tool under manual control to some "target point" on the table. The target point is some convenient place on the workpiece or table for the operator to position the tool. For example, it might be a predrilled hole in the workpiece. The target point has been referenced to the zero point by the part programmer. In fact, the programmer may have selected the target point as the zero point for tool positioning. When the tool has been positioned at the target point, the machine operator presses a "zero" button on the machine tool console, which tells the machine where the origin is located for subsequent tool movements.

## **34 NC MOTION CONTROL SYSTEMS**

In order to accomplish the machining process, the cutting tool and workpiece must be moved relative to each other. In NC, there are three basic types of motion control systems:

1. Point-to-point
2. Straight cut
3. Contouring

Point-to-point systems represent the lowest level of motion control between the tool and workpiece. Contouring represents the highest level of control.

### **1. Point-to-point NC**

Point-to-point (PTP) is also sometimes called a positioning system. In PTP, the objective of the machine tool control system is to move the cutting tool to a predefined location. The speed of path by which this movement is accomplished is not important in point-to-point NC. Once the tool reaches the desired location, the machining operation is performed at that position.



NC drill presses are a good example of PTP systems. The spindle must first be positioned at a particular location on the workpiece. This is done under PTP control. Then the drilling of the hole is performed at the location, and so forth. Since no cutting is performed between holes, there is no need for controlling the relative motion of the tool and workpiece between hole locations. Figure 3.3 illustrates the point-to-point type of control.

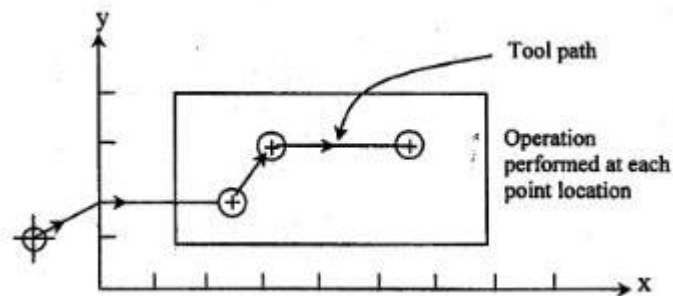

Figure 3.3 Point-to-point (positioning) NC system

Positioning systems are the simplest machine tool control systems and are therefore the least expensive of the three types. However, for certain processes, such as drilling operations and spot welding, PTP is perfectly suited to the task and any higher level of control would be unnecessary.

## 2. Straight-cut NC

Straight-cut control systems are capable of moving the cutting tool parallel to one major axis at a controlled rate suitable for machining (Figure 3.4). It is therefore appropriate for performing milling operations to fabricate workpieces of rectangular configurations. With this type of NC systems it is not possible to combine movements in more than a single axis direction. Therefore, angular cuts on the workpiece would not be possible. An example of a straight-cut operation is shown in figure. An NC machine capable of straight cut movements is also capable of PTP movements.

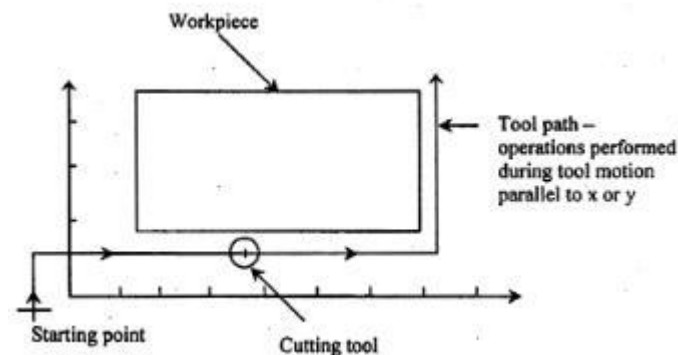

Figure 3.4 Straight-cut NC system

## 3. Contouring NC

Contouring is the most complex, the most flexible and most expensive type of machine tool control. It is capable of performing both PTP and straight-cut operations. In addition, the distinguishing feature of contouring NC systems is their capacity for simultaneous control of more than one axis movement of the machine tool. The path of the cutter is continuously controlled to generate the desired geometry of the workpiece. For this reason, contouring systems are also called continuous-path NC systems. Straight or plane surfaces at any

orientation, circular paths, conical shapes, or most any other mathematically definable form are possible under contouring control. Figure 3.5 illustrates the versatility of continuous path NC. Milling and turning operations are common examples of the use of contouring control.

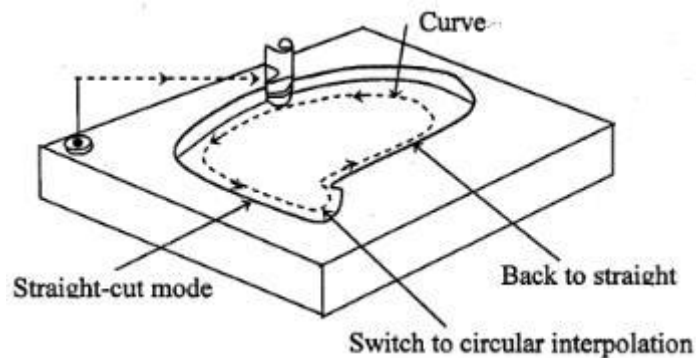

Figure 3.5 Contouring NC system

In order to machine a curved path in a numerical control contouring system, the direction of the feed rate must continuously be changed so as to follow the path. This is accomplished by breaking the curved path into very short straight-line segments that approximate the curve. Then the tool is commanded to machine each segment in succession. Besides these other NC systems are;

### Interpolator

The input speed is converted into the velocity components by an interpolator called the linear interpolator whose function is to provide the velocity signals to x and y directions. Similarly there are circular and parabolic interpolators (Figure 3.6).

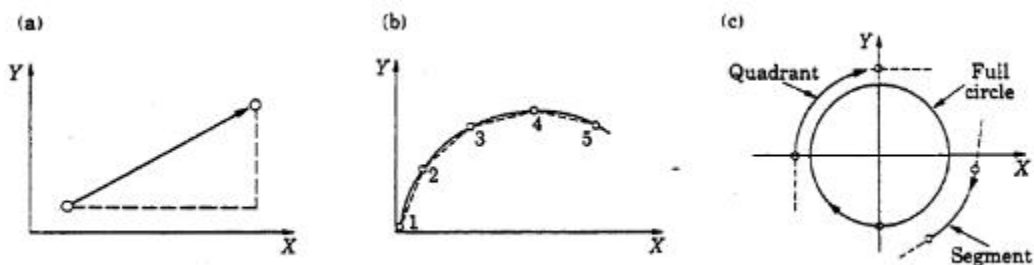

Figure 3.6 Interpolators

### Basic Length Unit (BLU)

Each BLU unit corresponds to the position resolution of the axis of motion. For example, 1 BLU = 0.0001" means that the axis will move 0.0001" for every one electrical pulse received by the motor. The BLU is also referred to as Bit (binary digit). Pulse = BLU = Bit

### Incremental and Absolute systems

NC systems are further divided into incremental and absolute systems (Figure 3.7). In incremental mode, the distance is measured from one point to the next. For example, if you want to drill five holes at different locations, the x-position commands are x+500, +200, +600, - 300, -700, -300. An absolute system is one in which all the moving commands are referred from a reference point (zero point or origin). For the above case, the x-position commands are x 500,700, 1300, 1000, 300, 0. (Figure 3.6). Both systems are incorporated in most CNC systems. For an inexperienced operator, it is wise to use incremental mode.

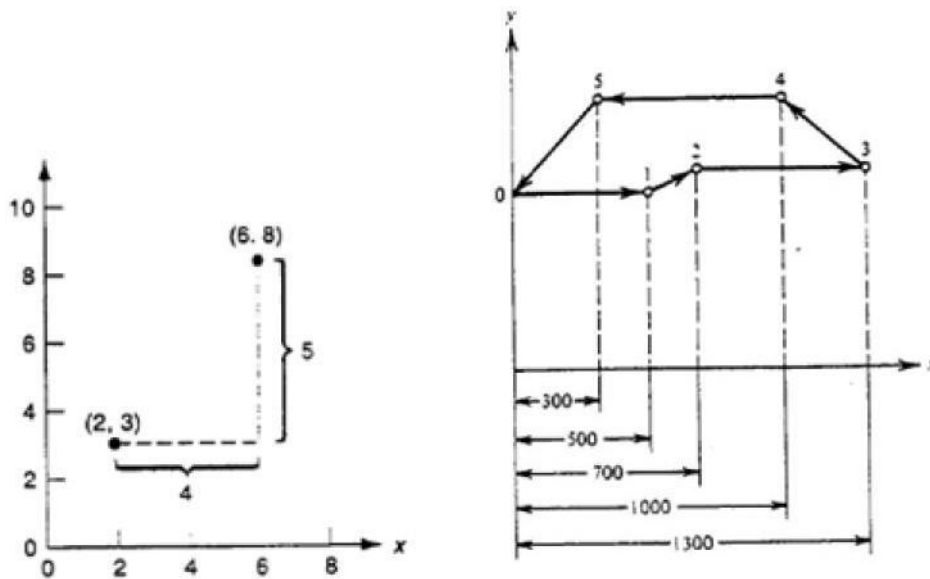

(a) Absolute versus incremental; In absolute positioning, the move is specified by  $x = 6$ ,  $y = 8$ ; in incremental, the move is specified by  $x=4$ ,  $y=5$  for the tool to be moved from  $(2,3)$  to  $(6,8)$

(b) Drilling 5-holes at different locations

Figure 3.7 Absolute and incremental systems

The absolute system has two significant advantages over the incremental system:

1. *Interruptions caused by, for example, tool breakage (or tool change, or checking the parts), would not affect the position at the interruption.* If a tool is to be replaced at some stage, the operator manually moves the table, exchanges the tool, and has to return the table to the beginning of the segment in which the interruption has occurred. In the absolute mode, the tool is automatically returned to the position. In incremental mode, it is almost impossible to bring it precisely to that location unless you repeat the part program
2. *Easy change of dimensional data.*

The incremental mode has two advantages over the absolute mode.

1. *Inspection of the program is easier because the sum of position commands for each axis must be zero. A nonzero sum indicates an error. Such an inspection is impossible with the absolute system.*
2. *Mirror image programming (for example, symmetrical geometry of the parts) is simple by changing the signs of the position commands.*

### 35 APPLICATIONS OF NUMERICAL CONTROL

Numerical control systems are widely used industry today, especially in the metal working industry. By far the most common application of NC is for metal cutting machine tools. Within this category, numerically controlled equipment has been built to perform virtually the entire range of material removal processes, including: Milling, Drilling and related processes, Boring, Turning, Grinding, and Sawing

Within the machining category, NC machine tools are appropriate for certain jobs and inappropriate for others. Following are the general characteristics of production jobs in metal machining for which numerical control would be most appropriate:

1. *Parts are processed frequently and is small lot sizes.*
2. *The part geometry is complex.*
3. *Many operations must be performed on the part in its processing.*
4. *Much metal needs to be removed*
5. *Engineering design changes are likely.*
6. *Close tolerances must be held on the workpart.*
7. *It is an expensive part where mistakes in processing would be costly.*
8. *The parts require 100% inspection.*

It has been estimated that most manufactured parts are produced in lot sized of 50 or fewer small-lot and batch production jobs represent the ideal situations for the application of NC. This is made possible by the capability to program the NC machine and to save that program for subsequent use in future orders. If the NC programs are long and complicated (complex part geometry, many operations, much metal removed), this makes NC all the more appropriate when compared to manual methods of production. If engineering design changes of shifts in the production schedule are likely, the use of tape control provides the flexibility needed to adapt to these changes. Finally, if quality and inspection are important issues (close tolerances, high part cost, 100% inspection required), NC would be most suitable, owing to its high accuracy and repeatability.

In order to justify that a job be processed by numerical control methods, it is not necessary that the job possess every one of these attributes. However, the more of these characteristics that are present, the more likely it is that the part is a good candidate for NC.

In addition to metal machining, numerical control has been applied to a variety of other operations. The following, although not a complete list, will give the reader an idea of the wide range of potential applications of NC:

Press working machine tools	Plasma arc cutting
Welding machines	Laser beam processes
Inspection machines	Automated knitting machines
Automatic drafting	Cloth cutting
Assembly machines	Automatic riveting
Tube bending	Wire-wrap machines
Flame cutting	

### 36 ADVANTAGES OF NUMERICAL CONTROL

1. **Reduced non-productive time.** Numerical control has little or no effect on the basic metal cutting (or other manufacturing) process. However, NC can increase the proportion of time the machine is engaged in the actual process. It accomplishes this by means of fewer setups, less time in setting up, reduced workpiece handling time, automatic tool changes on some machines and so on.
2. **Reduced fixturing.** NC requires fixtures which are simpler and less costly to fabricate because the positioning is done by the NC tape rather than the jig or fixture.
3. **Reduced manufacturing lead time.** Because jobs can be set up more quickly with NC and fewer setups are generally required with NC, the lead time to deliver a job to the customer is reduced.

4. **Greater manufacturing flexibility.** With numerical control it is less difficult to adapt to engineering design changes, alterations of the production schedule, changeovers in jobs for rush orders and so on.
5. **Improved quality control.** NC is ideal for complicated workparts where the chances of human mistakes are high; Numerical control produces parts with greater accuracy, reduced scrap and lower inspection requirements.
6. **Reduced inventory.** Owing to the fewer setups and shorter lead times with numerical control, the inventory carried by the company is reduced.
7. **Reduced floor space requirements.** Since one machining centre can often accomplish the production of several conventional machine, the amount of floor space required in an NC shop is usually less than in a conventional shop.

### **37 DISADVANTAGES OF NUMERICAL CONTROL**

1. **Higher investment cost.** Numerical control machine tool represent a more sophisticated and complex technology. This technology costs more to buy than its non-NC counterpart. The higher cost requires manufacturing managements to use these machines more aggressively than ordinary equipment. High machine utilization is essential in order to get reasonable return on investment. Machine shops must operate their NC machines two or three shifts per day to achieve this high machine utilization.
2. **Higher maintenance cost.** Because NC is a more complex technology and because NC machines are used harder, the maintenance problem becomes more acute. Although the reliability of the NC systems has been improved over the years, maintenance costs for NC machines will generally be higher than for conventional machine tools.
3. **Finding and/or training NC personnel.** Certain aspects of numerical control shop operations require higher skill level than conventional operations part programmers and NC maintenance personnel are two skill areas where available personnel are in short supply. The problem of finding, hiring and training these people must be considered a disadvantage to the NC shop.

### **38 NC PART PROGRAMMING**

Numerical control part programming is procedure by which the sequence of processing steps to be performed on the NC machine is planned and documented. It involves the preparation of a punched tape (or other input medium) used to transmit the processing instructions to the machine tool. There are two methods of part programming: manual part programming and computer-assisted part programming.

NC part programming can be started by examining the way in which the punched tape is coded. Coding of the punched tape is concerned with the basic symbols used to communicate a complex set of instructions to the NC machine tool. In numerical control, the punched tape must be generated whether the part programming is done manually or with the assistance of some computer package. With either method of part programming, the tape is the net result of the programming effort.

#### **Punched Tape in NC**

The part program is converted into a sequence of machine tool actions by means of the input medium. Which contains the program, and the controller unit, which interprets the input medium. The controller unit and the input medium must be compatible. That is, the input

medium uses coded symbols which represent the part program, and the controller unit must be capable of reading those symbols. The most common input medium is punched tape. The tape has been standardized so that tape punchers are manufactured to prepare the NC tapes, and tape readers (part of the controller unit) can be manufactured to read the tapes. The punched tape used for NC is 1 in. wide. It is standardized as shown in Figure 3.8 by the Electronics Industries Association (EIA), which has been responsible for many of the important standards in the NC industry.

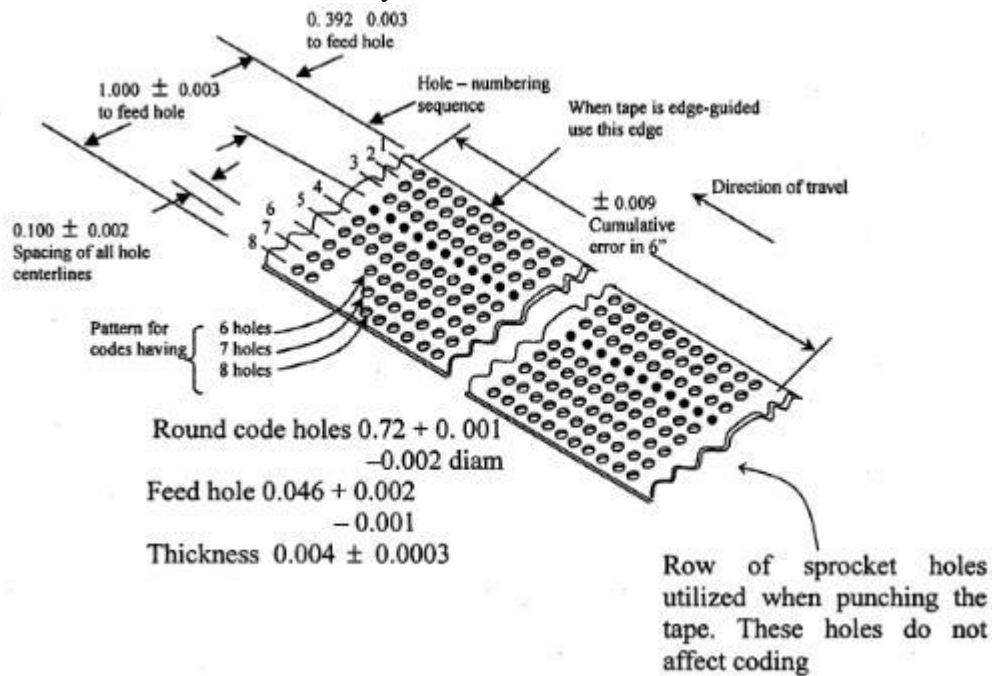

Figure 3.8 Punched tape format standardized by EIA

There are two basic methods of preparing the punched tape. The first method is associated with manual part programming and involves the use of a typewriter like device. The operator types directly from the part programmer's hand written list of coded instruction. This second method is used with computer-assisted part programming. By this approach, the tape is prepared directly by the computer using a device called a tape punch.

By either method of preparation, the punched tape is ready for use. During production on a conventional NC machine, the tape is fed through the tape reader once for each workpiece. It is advanced through the tape reader one instruction at a time. While the machine tool is performing one instruction, the next instruction is being read into the controller unit's data buffer. This makes the operation of the NC system more efficient. After the last instruction has been read into the controller, the tape is rewound back to the start of the program to be ready for the next workpart.

### **NC tape coding**

As shown in Figure 4.7, there are eight regular columns of holes running in the lengthwise direction of the tape. *There is also a ninth column of holes between the third and fourth regular columns. However, these are smaller and are used as sprocket holes for feeding the tape.* Figure shows a hole present in nearly every position of the tape. However, the coding of the tape is provided by either the presence or absence of a hole in the various positions. Because there are two possible conditions for each position- either the presence or absence of a hole- this coding system is called the binary code. It uses the base 2 number system, which

can represent any number in the more familiar base 10 or decimal system. The NC tape coding system is used to code not only numbers, but also alphabetical letters and other symbols. Eight columns provide more than enough binary digits to define any of the required symbols.

### **How instructions are formed?**

A binary digit is called a bit. It has a value of 0 or 1 depending on the absence or presence of a hole in a certain row and column position on the tape. (Columns of hole positions run lengthwise along the tape. Row positions run across the tape.) Out of a row of bits, a character is made. A character is a combination of bits, which represents a letter, number, or other symbol. A word is a collection of characters used to form part of an instruction. Typical NC words are x position, y position, cutting speed, and so on. Out of a collection of words, a block is formed. A block of words is a complete NC instruction. Using an NC drilling operation as an example, a block might contain information on the x and y coordinates of the hole location, the speed and feed at which the cut should be run, and perhaps even a specification of the cutting tool.

To separate blocks, an end-of-block (EOB) symbol is used (in the EIA standard, this is a hole in column 8). The tape reader feeds the data from the tape into the buffer in blocks. That is, it reads in a complete instruction at a time.

### **NC words**

Following is a list of the different types of words in the formation of a block. Not every NC machine uses all the words. Also, the manner in which the words are expressed will differ between machines. By convention, the words in a block are given in the following order:

<b>SEQUENCE NUMBER (N-words):</b>	This is used to identify the block.
<b>PREPARATORY WORD (G-words):</b>	This word is used to prepare the controller for instructions that are to follow. For example, the word G02 is used to prepare the NC controller unit for circular interpolation along an arc in the clockwise direction. The preparatory word is needed so that the controller can correctly interpret the data that follow. It is in the block.
<b>COORDINATES (X-, Y-, and Z-words):</b>	These give the coordinate positions of the tool. In a two-axis system, only two of the words would be used. The + sign to define a positive coordinate location is optional. The negative sign is mandatory.
<b>FEED RATE (F-word):</b>	This specifies the feed in a machining operation. Units are mm per minute by convention.
<b>CUTTING SPEED (S- word):</b>	This specifies the cutting speed of the process, the rate at which the spindle rotates.
<b>TOOL SELECTION (T- word):</b>	This word would be needed only for machines with a tool turret or automatic tool changer. The T-word specifies which tool is to be used in the operation.
<b>MISCELLANEOUS FUNCTION (M – word)</b>	The M-word is used to specify certain miscellaneous or auxiliary functions which may be available on the machine tool. Of course, the machine must possess the function that is being called. An example would be M03 to start the spindle rotation.

### **3.8.1 Manual Part Programming**

To prepare a part program using the manual method, the programmer writes the machining instructions on a special form called a part programming manuscript. The instruction must be

prepared in a very precise manner because the typist prepares the NC tape directly from the manuscript. Manuscripts come in various forms, depending on the machine tool and tape format to be used. For example, the manuscript form for a two-axis point-to-point drilling machine would deferent than one for a three-axis contouring machine. The manuscript is a listing of the relative tool and workpiece locations. It also includes other data, such as preparatory commands, miscellaneous instructions, and speed /feed specifications, all of which are needed to operate the machine under tape control.

Manual programming jobs can be divided into two categories: point-to-point jobs and contouring jobs. Except for complex workparts with many holes to be drilled, manual programming is ideally suited point-to-point applications. On the other hand, except for the simplest milling and turning jobs, manual programming can become quite time consuming for applications requiring continuous-path control of the tool. Accordingly, we shall be concerned only with manual part programming for point-to-point operations. Contouring is much appropriate for computer-assisted part programming.

**Example 1:**

Suppose that the part to be programmed is a drilling job. The engineering drawing for the part is presented in figure. Three holes are to be drilled at a diameter of  $^{31}_{64}$  in. The close hole size tolerance requires reaming to 0.500 in. diameter. Recommended speeds and feeds are as follows:

Speed (rpm)	Speed (rpm)	Feed (in./min)
0.484-in- diameter drill	592	3.55
0.500-in.-diameter drill	382	3.82

The NC drill press operates as follows. Drill bits are manually changed by the machine operator, but speeds and feeds must be programmed on the tape. The machine has the floating-zero feature and absolute positioning.

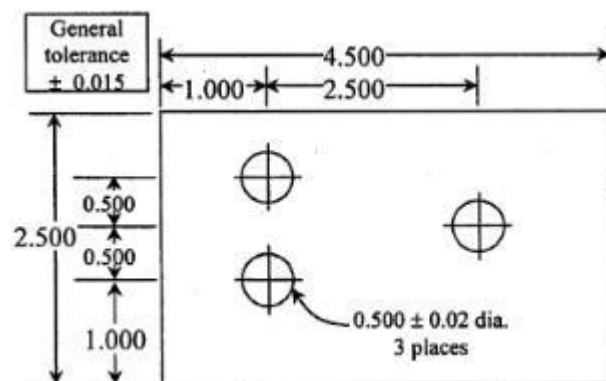

Part drawing for Example 1

The first step in preparing the part program is to define the axis coordinates in relation to the workpart. We assume that the outline of the part has already been machined before the drilling operation. Therefore, the operator can use one of the corners of the part as the target point. Let us define the lower left-hand corner as the target point and the origin of four-axis system. The coordinates are shown in figure, for the example part. The *x* and *y* locations of each hole can be seen in the figure. The completed manuscript would appear as in figure. The first line shows the *x* and *y* coordinates at the zero point. The machine operator would insert the tape and read this first block into the system. (A block of instruction corresponds



generally to one line on the manuscript form). The tool would then be positioned over the target point on the machine table. The operator would then press the zero buttons to set the machine.

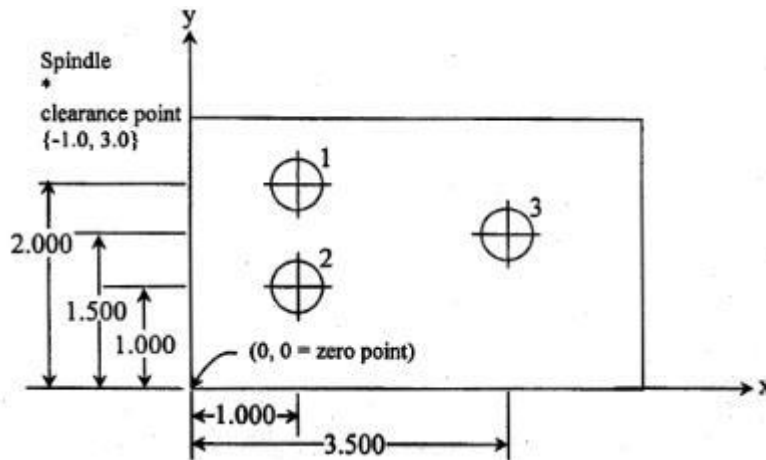

Coordinate system defined for part in Example 1

The next line on the manuscript is RWS, which stands for rewind-stop. This signal is coded into the tape as holes in columns 1, 2, and 4. The symbol stops the tape after it has been rewound. The last line on the tape contains the m30 word, causing the tape to be rewound at the end of the machining cycle. Other m-words used in the program are m06, which stops the machine for an operator tool change, and m13, which turns on the spindle and coolant. Note in the last line that the tool has been repositioned away from the work area to allow for changing the workpiece.

**NC part programming manuscript**  
Two axis point-to-point drill press  
Tab sequential format

Part No. \_\_\_\_\_ Date 01/09/04  
Part Name HOLE PLATE Prepared by \_\_\_\_\_

Seq. No.	Tab EOB	x-COORD	Tab EOB	y-COORD	Tab EOB	Feed	Tab EOB	Speed	Tab EOB	m-WORD	Tab EOB	Comments
00	TAB	0.0	TAB	0.0	EOB							ZERO
RWS												
01	TAB	1.0	TAB	2.0	TAB	3.55	TAB	592	TAB	13	EOB	DRILL 1
02	TAB		TAB	1.0	EOB							DRILL 2
03	TAB	3.5	TAB	1.5	EOB							DRILL 3
04	TAB	-1.0	TAB	3.0	TAB		TAB		TAB	06	EOB	TOOL CHG
05	TAB	3.5	TAB	1.5	TAB	3.82	TAB	382	TAB	13	EOB	REAM 3
06	TAB	1.0	TAB	1.0	EOB							REAM 2
07	TAB		TAB	2.0	EOB							REAM 1
08	TAB	-1.0	TAB	3.0	TAB		TAB		TAB	06	EOB	TOOL CHG
09	TAB		TAB		TAB		TAB		TAB	30	EOB	REWIND & CHG PART

**Part program manuscript for Example 1**

### 3.8.2 Computer-assisted Part Programming

In the more complicated point-to-point jobs and in contouring applications manual part programming becomes an extremely tedious task and subject to errors. In these instances it is

much more appropriate to employ the high-speed digital computer to assist in the part programming process. Many part programming language systems have been developed to perform automatically most of the calculations, which the programmer would otherwise be forced to do. This saves time and results in a more accurate and more efficient part program.

### **The part programmer's job**

In computer-assisted part programming, the NC procedure for preparing the tape from the engineering drawing is followed as usual. The machining instructions are written in English-like statements of the NC programming language, which are then processed by the computer to prepare the tape. The computer automatically punches the tape in the proper tape format for the particular NC machine. The part programmer's responsibility in computer-assisted part programming consists of two basic steps:

1. Defining the workpart geometry
2. Specifying the operation sequence and the tool path

No matter how complicated the workpart may appear, it is composed of basic geometric elements. Although somewhat irregular in overall appearance, the outline of the parts consists of intersecting straight, and a partial circle. The holes in the part can be expressed in terms of the center location and radius of the hole. Nearly any components that can be conceived by a designer can be described by points, straight lines, planes, circles, cylinders, and other mathematically defined surfaces. It is the part programmer's task to enumerate the elements out of which the part is composed. Each geometric element must be identified and the dimensions and location of the element explicitly defined.

After defining the workpart geometry, the programmer must next construct the path that the cutter will follow to machine the part. This tool path specification involves a detailed step-by-step sequence of cutter moves. The moves are made along the geometry elements, which have previously been defined. The part programmer can use the various motion commands to direct the tool to machine along the workpart surfaces, to go to point locations, to drill holes at these locations and so on. In addition to part geometry and tool motion statements, the programmer must also provide other instructions to operate the machine tool properly.

### **The computer's job**

The computer's job in computer-assisted part programming consists of the following steps:

1. Input translation
2. Arithmetic calculations
3. Cutter offset computation
4. Post processor

The sequence of these steps and their relationships to, the part programmer and the machine tool are illustrated in Figure 3.9.

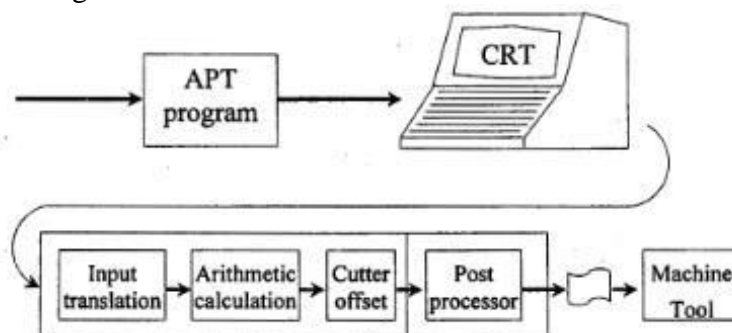

Figure 3.9 Computer's job in computer-assisted part programming

The task of the part programmer is that of constructing the tool path. However, the actual tool path is different from the part outline because the tool path is defined as the path taken by the center of the cutter. It is at the periphery of the cutter that machining takes place. The purpose of the cutter offset computations is to offset from the desired part surface by the radius of the cutter. This means that the part programmer can define exact part outline in the geometry statements. Thanks to the cutter offset calculation provided by the programming system, the programmer need not be concerned with this task.

As noted previously, NC machine tool systems are different. They have different features and capabilities. They use different NC tape formats. Nearly all of the part programming languages, including APT, are designed to be general purpose languages, not limited to one or two machine tool types. Therefore, the final task of the computer in computer-assisted part programming is to take the general instructions and make them specific to a particular machine tool system. The unit that performs this task is called a postprocessor.

The postprocessor is a separate computer program that has been written to prepare the punched tape for a specific machine tool. The input to the postprocessor is the output from the other three components: a series of cutter locations and other instructions. The output of the postprocessor is the NC tap written in the correct format for the machine on which it is to be used.

### **3.8.3 NC Part Programming Languages**

An NC part programming language consists of a software package (computer program) plus the special rules, conventions, and vocabulary words for using that software. Its purpose is to make it convenient for a part programmer to communicate the necessary part geometry and tool motion information to the computer so that the desired part geometry and tool motion information to the computer so that the desired part program can be prepared. The vocabulary words are typically mnemonic and English-like, to make the NC language easy to use.

Most of the languages were developed to meet particular needs and have not survived the test of time. The following list provides a description of some of the important NC languages in current use.

APT (Automatically Programmed Tools)	The APT language was the product of the MIT developmental work on NC programming systems. Today it is the most widely used language in the United States. Although first intended as a contouring language, modern versions of APT can be used for both positioning and continuous-path programming in up to five axes. Versions of APT for particular processes include APTURN (for lathe operations), APTMIL (for milling and drilling operations), and APTPOINT (for point-to-point operations).
ADAPT (Adaptation of APT)	Several part programming languages are based directly on the APT program. One of these is ADAPT, which was developed by IBM under Air Force contract. It was intended to provide many of the features of APT but to utilize a smaller computer. The full APT program requires a computing system that would have been considered by the standards of the 1960s. This precluded its use by many small and medium-sized firms that did not have access to a large computer. ADAPT is not as powerful as APT, but it can be used to program for both positioning and contouring jobs.
EXAPT (Extended subset of APT)	There are three versions: EXAPT I- designed for positioning (drilling and also straight-cut milling), EXAPT II- designed for turning, and EXAPT III- designed for limited contouring operations. One of the important features of EXAPT is that it attempts to compute optimum feeds and speeds automatically.
UNIAPT	The UNIAPT package represents another attempt to adapt the APT language to use on smaller computers. The name derives from the developer, the United Computing Corp. of Carson, California. Their efforts have provided a limited version of APT to be implemented on minicomputers, thus allowing many smaller shops to possess computer-assisted programming capacity.
SPLIT (Sundstrand Processing Language Internally Translated)	This is a proprietary system intended for Sundstrand's machine tools. It can handle up to five-axis positioning and possesses contouring capability as well. One of the unusual features of SPLIT is that the postprocessor is built into the program. Each machine tool uses its own SPLIT package, thus obviating the need for a special postprocessor.
COMPACT II	This is a package available from Manufacturing Data Systems, Inc. (MDSI), a firm based in Ann Arbor, Michigan. The NC language is similar to SPLIT in many of its features. MDSI leases the COMPACT II system to its users on a time-sharing basis; the part programmer uses a remote terminal to feed the program into one of the MDSI computers, which in turn produces the NC tape. The COMPACT II language is one of the most widely used programming languages. MDSI has roughly 3000 client companies, which use this system.
PROMPT	This is an interactive part programming language offered by Weber N/C System, Inc., of Milwaukee, Wisconsin. It is designed for use with a variety of machine tools, including lathes, machining centers, flame cutters, and punch presses.
CINTURN II	This is a high-level language developed by Cincinnati Milacron to facilitate programming of turning operations.

The most widely used NC part programming language is APT, including its derivatives (ADAPT, EXAPT, UNIAPT, etc.).

### 3.8.4 APT Language

There are four types of statements in the APT language:

1. Geometry statements- These define the geometric elements that comprises the workpart. They are also sometimes called definition statements.
2. Motion statements- These are used to describe the path taken by the cutting tool.
3. Postprocessor statements- These apply to the specific machine tool and control system. They are used to specify feeds and speeds and to actuate other features of the machine.
4. Auxiliary statements- These are miscellaneous statements use to identify the part, tool, tolerance, and so on.

#### Geometry statements

To program in APT, the workpart geometry must first be defined. The tool is subsequently directed to move to the various point locations and along surfaces of the workpart, which have been defined by these geometry statements. The definition of the workpart elements must precede the motion statements. The general form of APT geometry statements is:

$$\text{symbol} = \text{geometry type/descriptive data} \quad (1)$$

An example of such a statements is

$$P1 = \text{POINT/ 5.0, 4.0, 0.0} \quad (2)$$

The statement is made up of three sections. The first is the symbol used to identify the geometric element. A symbol can be combination of six or fewer alphabetic and numeric characters. At least one of the six must be an alphabetic character. Also, although it may seem obvious, the symbol cannot be one of the APT vocabulary words.

The second section of the geometry statements is an APT vocabulary word that identifies the type of geometry elements. Besides POINT, other geometry elements in the APT vocabulary include LINE, PLANE and CIRCLE.

The third section of the geometry statements comprises the descriptive data that define the element precisely, completely, and uniquely. These data may include, quantities dimensional and positional data, previously defined geometry elements, and other APT word.

The punctuation used in the APT geometry statements is illustrated in the example, Eq. (2). The statements is written as an equation, the symbol being equated to the surface type. A slash separates the surface type from the descriptive data. Commas are used to separate the words and numbers in the descriptive data.

There are several ground rules that must be followed in formulating an APT geometry statement:

1. The coordinates data must be specified in the order  $x, y, z$ . for example, the statement  
$$P1 = \text{POINT/5.0, 4.0, 0.0}$$
is interpreted by the APT program to mean a point  $x = 5.0, y = 4.0$ , and  $z = 0.0$ .
2. Any symbols used as descriptive data must have been previously defined. For example, in the statement

$$P2 = \text{POINT/INTOF, L1, L2}$$

the two lines L1 and L2 must have been previously defined. In setting up the list statements, the APT programmer must be sure to define symbols before using them in subsequent statements.

3. A symbol can be used to define only one geometry element. The same symbol cannot be used to define two different elements. For example, the following sequence would be incorrect:

```
P1 = POINT /1.0, 1.0, 1.0
P1 = POINT / 2.0, 3.0, 4.0
```

4. Only one symbol can be used to define any given element. For example, the following two statements in the same program would render the program incorrect:

```
P1 = POINT/1.0, 1.0, 1.0
P2 = POINT 1.0, 1.0, 1.0
```

5. Lines defined in APT are considered to be of infinite length in both directions. Similarly, planes extend indefinitely and circles defined in APT are complete circles.

### **To specify a point**

P0 = **POINT**/1.0, 1.2, 1.3 *specifies a point at XYZ coordinates 1.0, 1.2, and 1.3, respectively.*

P1 = **POINT/INTOF** L1, L2 *specifies a point at the intersection of lines L1 and L2, which must have been defined prior to the statement.*

P2 = **POINT/YLARGE, INTOF, L3, C1**  
*line L3*  
*center* *specifies a point at the intersection of and circle C1 at a Y position above the point of the circle.*

### **To specify a line**

L1 = **LINE**/P0, P1 *specifies a line by two points, previously defined.*

L1 = **LINE**/1.0, 1.2, 1.3, 2.0, 2.1, 2.3 *specifies a line by two points, given as explicit coordinates.*

L2 = **LINE**/P2, **PARLEL**, L1 *specifies a line through point P2 and parallel to line L1.*

L3 = **LINE**/P1, **RIGHT, TANTO, C1** *specifies a line through point P1 and tangent to circle C1 on the right side of the center point.*

L4 = **LINE**/P1, **ATANGL**, 45, L1 *specifies a line through point P1 at an angle of 45° to line L1.*

### To specify a plane

PL0 = **PLANE/P0, P1, P2**

*specifies a plane through three, non-collinear, previously defined points.*

PL1 = **PLANE/P3, PARLEL, PL0**

*specifies a plane through a point P3 parallel to a plane PL0.*

### To specify a circle

C0 = **CIRCLE/CENTER, P0, RADIUS, 1.0**

*specifies a circle of radius 1 from a center point of P0.*

### Motion statements.

APT motion statements have general format, just as the geometry statements do. The general form of a motion statements is

motion command/descriptive data (3)

An example of a motion statements is

GOTO/P1 (4)

The statement consists of two sections separated by a slash. The first section is the basic motion command, which tells the tool what to do. The second section comprised of descriptive data, which tell the tool where to go. In the example statement above, the tool is commanded to go to point P1, which has been defined in a proceeding geometry statement.

At the beginning of the motion statements, the tool must be given a starting point. This point is likely to be the target point, the location where the operator has positioned the tool at the start of the job. The part programmer keys into this starting position with the following statement:

FROM/TARG (5)

The FROM is an APT vocabulary word which indicates that this is the initial point from which others will be referenced. In the statements above, TARG is the symbol given to the starting point. Any other APT symbol could be used to define the target point. Another way to make this statement is

FROM/-2.0, -2.0, 0.0

where the descriptive data in this case are the x, y, and z coordinates of the target point. The FROM statements occurs only at the start of the motion sequence.

It is convenient to distinguish between PTP movements and contouring movements when discussing the APT motion statements.

### **Point-to-point motions**

There are only two basic PTP motion commands: GOTO and GODLTA. The GOTO statement instructs the tool to go to a particular point location specified in the descriptive data. The GODLTA command specifies an incremental move for the tool.

The GODLTA command is useful in drilling and related operations. The tool can be directed to a particular hole location with the GOTO statements. Then the GODLTA command would be used to drill the hole, as in the following sequence:

GOTO/P2  
GODLTA/0, 0, -1.5  
GODLTA/0, 0, +1.5

## Contouring Motions

Contouring commands are somewhat more complicated because the tool's position must be continuously controlled throughout the move. To accomplish this control, the tool is directed along two intersecting surfaces as shown in Figure 3.10. These surfaces have very specific name in APT.

1. Drive surface- this is the surface (it is pictured as a plane in figure) that guides the side of the cutter.
2. Part surface- this is the surface (again shown as a plane in the figure) on which the bottom of the cutter rides. The reader should note that the "part surface" may or may not be an actual surface of the workpart. The part programmer must define this plus the drive surface for the purpose of maintaining continuous path control of the tool.

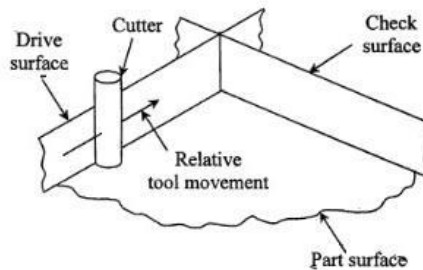

Three surfaces in APT contouring motions which guide the cutting tool

Figure 3.10 Surfaces in APT

3. Check surface- this is the surface that stops the movement of the tool in its current direction. In a sense it checks the forward movement of the tool.

There are several ways in which the check surface can be used. This is determined by APT modifier words within the descriptive data of the motion statement. The three main modifier words are TO, ON and PAST, and their use with regard to the check surface is shown in Figure 3.11. A fourth modifier word is TANTO. This is used when the drive surface is tangent to a circular check surface as illustrated in Figure 3.12. In this case the cutter can be brought to point of tangency with the circle by the TANTO modifier word.

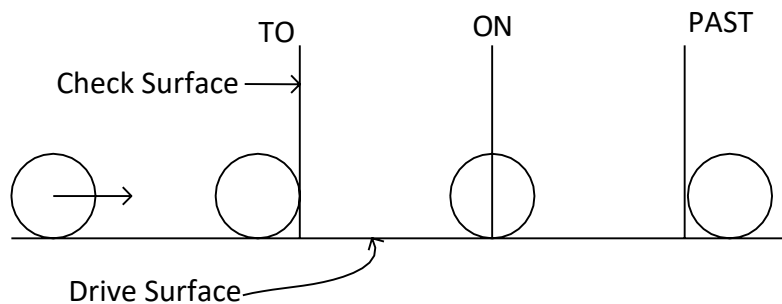

Figure 3.11 ON TO PAST Modifier words

The **TO** modifier stops the tool when the *first surface* of the tool would come into contact with the check surface. The **ON** modifier stops the tool where the *center point* of the tool would come into contact with the check surface. The **PAST** modifier stops the tool where the *last surface* of the tool would contact the check surface. And the **TANTO** modifier stops the tool at the point of circular tangency with the *edge* of the tool.



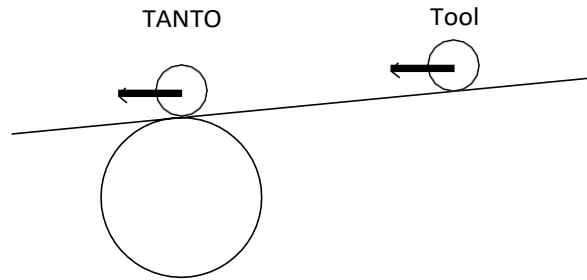

Figure 3.11 TANTO Modifier word

The initial contouring motion statement is the **GO/TO**, which defines the initial drive, part and check surfaces. It takes the form:

**GO/TO**, drive surface, **TO**, part surface, **TO**, check surface

An example would be:

**GO/TO**, L1, **TO**, PL1, **TO**, L2      *specifying that the tool should use line L1 as the drive surface, plane P1 as the part surface, and line L2 as the check surface.*

Note: the **GOTO** and the **GO/TO** statements *are not the same*. The former specifies **point to point** motion (see below), and the latter initiates **contouring** motion.

Continuing contouring motion statements are given from the vantage point of a person sitting on the top of the tool. The motion words are: (a) **GOLFT**; (b) **GORGT**; (c) **GOFWD**; (d) **GOBACK**; (e) **GOUP**; and (f) **GODOWN**. The sense of these words depends on the direction the tool has been coming from, and is depicted in Figure 3.13.

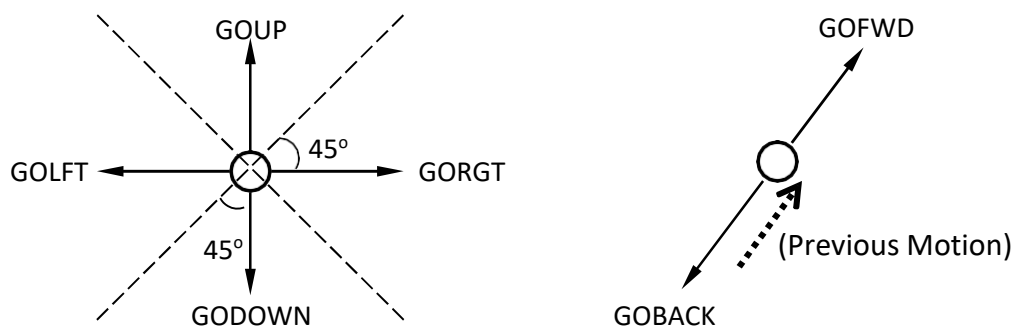

Figure 3.12 Motion words in NC

### **Postprocessor statements**

To write a complete part program, statements must be written that control the operation of the spindle, the feed and other features of the machine tool. These are called postprocessor statements. Some of the common postprocessor statements are:

<b>COOLNT/</b>	<b>RAPID</b>
<b>END</b>	<b>SPINDL/</b>
<b>FEDRAT</b>	<b>TURRET/</b>
<b>MACHIN/</b>	

The postprocessor statements, and the auxiliary statements are of two forms: either with or without the slash (/). The statements with the slash are self-contained. No additional data are needed. The APT words with the slash require descriptive data after the slash.

The FEDRAT/ statements should be explained. FEDRAT stands for feed rate and the interpretation of for different machining operations. In a drilling operation the feed is in the direction of the drill bit axis. However, in an end milling operation, typical for NC, the feed would be in a direction perpendicular to the axis of the cutter.

### **Auxiliary statements**

The complete APT program must also contain various other statements, called auxiliary statements. These are used for cutter size definition, part identification, and so on. The following APT words used in auxiliary statements are:

<b>CLPRNT</b>	<b>INTOL/</b>
<b>CUTTER</b>	<b>OUTOL/</b>
<b>PARTNO</b>	

### **The macro statements in apt**

The MACRO feature is similar to a subroutine computer programming language. It would be used where certain motion sequences would be repeated several times within a program. The purpose in using a MACRO subroutine is to reduce the total number of statements required in the APT program, thus making the job of the part programmer easier and less time consuming. The MACRO subroutine is defined by a statement of the following format:

**symbol = MACRO/parameter definition(s) (6)**

The rules for naming the MACRO symbol are the same as for any other APT symbol. It must be six characters or fewer and at least one of the characters must be a letter of the alphabet. The parameter definition(s) following the slash would identify certain variables in the subroutines which might change each time the subroutine was called into use. Equation 6 would serve as the title and first line of a MACRO subroutine. It would be followed by the set of APT statements that comprise the subroutine. The very last statements in the set must be the APT word TERMAC. This signifies the termination of the MACRO.

To activate the MACRO subroutine within an APT program; the following call statements would be used:

**CALL/symbol, parameter specification**

The symbol would be the name of the MACRO that is to be called. The parameter specification identifies the particular values of the parameters that are to be used in this execution of the MACRO subroutines.

### Example-1

An APT program for the profiling of the part in the following Figure is to be generated. The processing parameters are: (a) feed rate is 5.39 inches per minute; (b) spindle speed is 573 revolutions per minute; (c) a coolant is to be used to flush the chips; (d) the cutter diameter is to be 0.5 inches, and (e) the tool home position is (0, -1, 0).

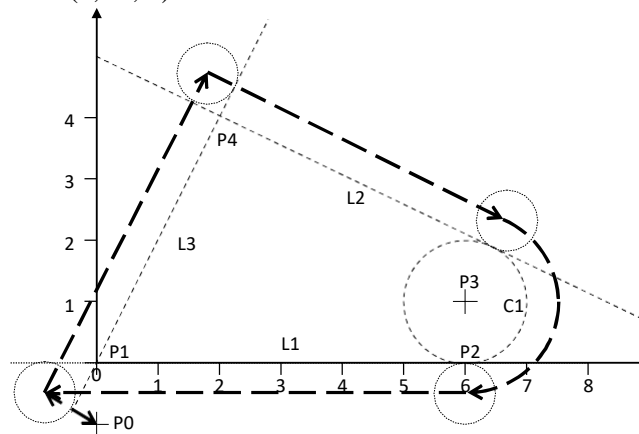

### APT Program Listing

```

PARTNO EXAMPLE
MACHIN/MILL, 1
CUTTER/0.5000
P0 = POINT/0, -1.0, 0
P1 = POINT/0, 0, 0
P2 = POINT/6.0, 0, 0
P3 = POINT/6.0, 1.0, 0
P4 = POINT/2.0, 4.0, 0
L1 = LINE/P1, P2
C1 = CIRCLE/CENTER, P3, RADIUS, 1.0
L2 = LINE/P4, LEFT, TANTO, C1
L3 = LINE/P1, P4
PL1 = PLANE/P1, P2, P3
SPINDL/573
FEDRAT/5.39
COOLNT/ON
FROM/P0
GO/PAST, L3, TO, PL1, TO, L1

GOUP/L3, PAST, L2
GORGT/L2, TANTO, C1
GOFWD/C1, ON, P2
GOFWD/L1, PAST, L3
RAPID
GOTO/P0
COOLNT/OFF
FINI

```

labels the program "EXAMPLE"  
 selects the target machine and controller type  
 specifies the cutter diameter

geometry statements to specify the  
 pertinent surfaces of the part

sets the spindle speed to 573 rpm  
 sets the feed rate to 5.39 ipm  
 turns the coolant on  
 gives the starting position for the tool  
 initializes contouring motion; drive, part, and check  
 surfaces

motion statements to contour the part  
 in a clockwise direction

move rapidly once cutting is done  
 return to the tool home position  
 turn the coolant off  
 end program

### Example-2

```

PARTNO P1534
MACHIN/MILL, 4
CLPRINT
OUTTOL/0.0015
P0 = POINT/ 0, 0, 1.1
P1 = POINT/ 1, 1, 0.5
P2 = POINT/ 4, 3.5, 0.5
P3 = POINT/ 5.85, 2.85, 0.5
PL1 = PLANE/ P1, P2, P3
PL2 = PLANE/ PARLEL, PL1, ZSMALL, 0.5
P4 = POINT/ 5, 1.85, 0.5
P5 = POINT/ 2, 2.5, 0.5
C1 = CIRCLE/ CENTER, P4, RADIUS, 0.85
C2 = CIRCLE/ CENTER, P5, RADIUS, 1.0
L1 = LINE/ P1, RIGHT, TANTO, C1
L2 = LINE/ P3, LEFT, TANTO, C1
L3 = LINE/ P2, P3
L4 = LINE/ P2, RIGHT, TANTO, C2
L5 = LINE/ P1, LEFT, TANTO, C2
MILLS = MACRO/ CUT, SSP, FRT, CLT
CUTTER/ CUT
  
```

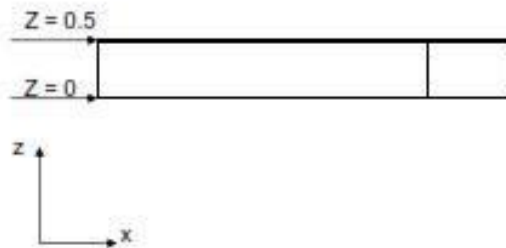
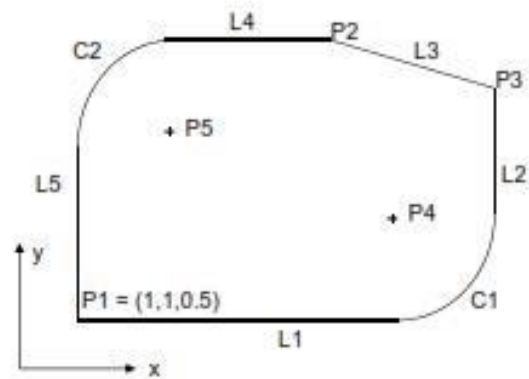

### Example-3

```

P0 = POINT/ 0, -2, 0
P1 = POINT/ 0.312, 0.312, 0
P2 = POINT/ 4, 1, 0
C1 = CIRCLE/ CENTER, P1, RADIUS, 0.312
C2 = CIRCLE/ CENTER, P2, RADIUS, 1
L2 = LINE/ RIGHT, TANTO, C2, RIGHT, TANTO, C1
L1 = LINE/ LEFT, TANTO, C2, LEFT, TANTO, C1
PL1 = PLANE/ P0, P1, P2
FROM/ P0
GO/TO, L1, TO, PL1, TO, C2
GOLF/ L1, TANTO, C1
GOFWD/ C1, PAST, L2
GOFWD/ L2, TANTO, C2
GOFWD/ C2, PAST, L1
GOTO/ P0
  
```

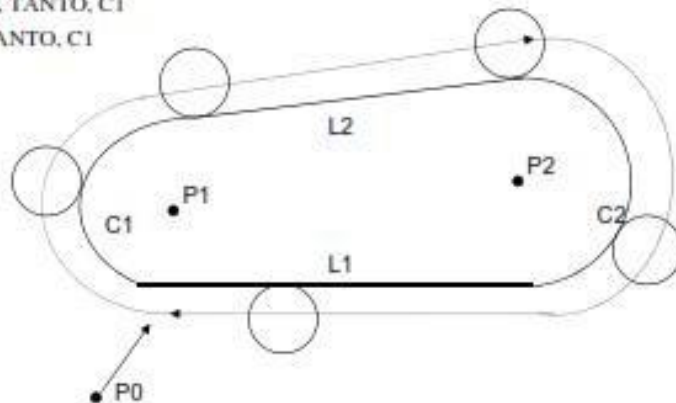

### Example-4

```

P0 = POINT/ -1, -1, 3
P1 = POINT/ 0, 0
P2 = POINT/ 3, 0
P3 = POINT/ 4, 0
P4 = POINT/ 6.5, 5.5
C1 = CIRCLE/ CENTER, P3, RADIUS, 1
L0 = LINE/ P1, P2
L1 = LINE/ (POINT/ 5, 1), LEFT, TANTO, C1
L2 = LINE/ (POINT/ 7, 1), PERPTO, L1
C2 = CIRCLE/ CENTER, P4, RADIUS, 0.5
L3 = LINE/ (POINT/ 7, 1), RIGHT, TANTO, C2
L4 = LINE/ (POINT/ 5, 6), LEFT, TANTO, C2
C3 = CIRCLE/ CENTER, (POINT/ 4, 6), (POINT/ 3, 6)
L5 = LINE/ (POINT/ 0, 6), (POINT/ 3, 6)
L6 = LINE/ P1, PERPTO, L5
PL1 = PLANE/ P1, P2, P3

```

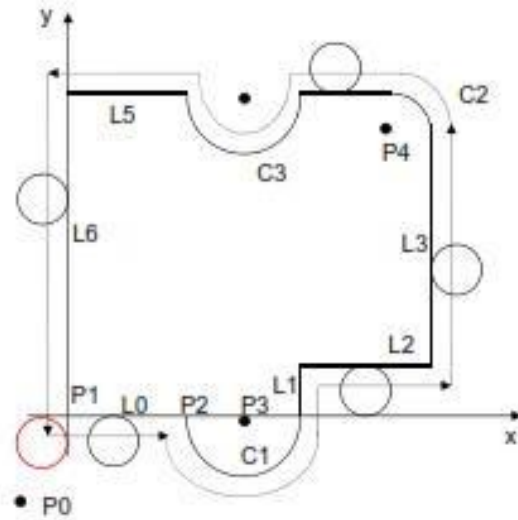

```

FROM/ P0
GO/ TO, L0, TO, PL1, TO, L6
GODLTA/ 0,0,-1
GORG/ L0, TO, C1
GORG/ C1, TANTO, L1
GOFWD/ L1, TO, L2
GORG/ L2, PAST, L3
GOLFT/ L3, TANTO, C2
GOFWD/ C2, TANTO, L4
GOFWD/ L4, PAST, C3
GOLFT/ C3, PAST, L5
GOLFT/ L5, PAST, L6
GOLFT/ L6, PAST, L0
GODLTA/ 0,0,1
GOTO/ P0

```

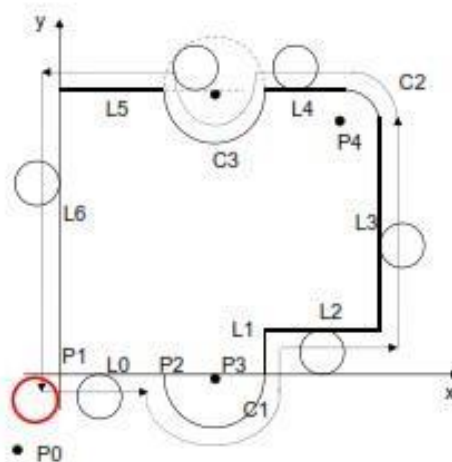

Thickness= 1inch.

### Programming with interactive graphics

The first involves the use of interactive graphics as a highly productive aid in performing the part programming process. We cover this topic in the present section. The second innovation is voice programming. This involves the input of NC programming statements through oral communication by the human programmer. The third development during the past few years is manual data input (MDI) of the NC part program. In a sense, this involves a step backward in NC programming technology.

The use of interactive graphics in NC part programming is an excellent example of the integration of computer-aided design and computer-aided manufacturing. The programming procedure is carried out on the graphics terminal of a CAD/CAM system. Using the same geometric data which defined the part during the computer-aided design process, the programmer constructs the tool path using high-level commands to the system. In many cases

the tool path is automatically generated by the software of the CAD/CAM system. The output resulting from the procedure is a listing of the APT program or the actual CLFILE (cutter location file) which can be post-processed to generate the NC punched tape.

Let us consider the step-by-step procedure that would be used to generate the NC part program using a CAD/CAM system. We will then illustrate the procedure with an example. All of the major CAD/CAM system vendors offer part programming packages. Although the features of these packages vary between the vendors, they all operate in a similar way. In our description of the procedure we will attempt to portray a composite of the various packages.

### **Initial steps in the procedure**

The CAD/CAM procedure for NC programming begins with the geometric definition of the part. A significant benefit of using a CAD/CAM system is realized when these geometry data have already been created during design. If the geometric model of the part has not been previously created, it must be constructed on the graphics terminal.

With the part displayed on the CRT screen, the programmer would proceed to label the various surfaces and elements of the geometry. The CAD/CAM system would accomplish the labelling in response to a few simple commands by the programmer. After labelling is completed, the APT geometry statements can be generated automatically by the system.

In addition to the ease with which the APT geometry has been defined using the CAD/CAM system, there are several other benefits afforded the user of a graphics system for NC part programming. The part can be displayed at various angles, magnifications, and cross sections to examine potential problem areas in machining. This capability to manipulate the part image on the CRT screen is helpful to the programmer in visualizing the design of the part. Also, with the part defined in the computer, the programmer can overlay the outline of the raw workpart to consider the number of passes required to complete the machining. Alternative methods of fixturing the part can be explored using the graphics terminal.

Tool selection is the next step in the procedure. The CAD/CAM system would typically have a tool library with the various tools used in the shop catalogued according to the type. The programmer could either select one of these tools or create a new tool design by specifying the parameters and dimensions of the new tools (diameter, corner radius, cutter length, etc.)

### **Generation of the tool path**

At this point in the procedure, the programmer has a geometric model of the workpart and the tools needed to machine the part. The next step is to create the cutter path. The method of accomplishing this using interactive graphics depends on the type of operation. (e.g., profile milling, turning, sheet metal working) and the complexity of the part. The currently available commercial CAD/CAM systems use an interactive approach, with certain common machining routines being done automatically by the system. These automatic routines might include profile milling around a part outline, end milling a pocket, point-to-point, PTP presswork hole piercing, and surface contouring.

The interactive approach permits the programmer to generate the tool path in a step-by-step manner with visual verification on the graphics display. The procedure begins by defining a starting position for the cutter. The programmer would then command the tool to move along the defined geometric surfaces of the part. As the tool is being moved on the CRT screen, the corresponding APT motion commands are automatically prepared by the CAD/CAM system.

The interactive mode provides the user with the opportunity to insert postprocessor statements at appropriate points during program creation. These post-processor statements would consist of machine tool instructions such as feed rates, speeds, and control of the cutting fluid.

The automatic machining routines are called into operation for frequently encountered part programming situations. These routines are analogous to high level MACRO subroutines which have been developed as part of the CAD/CAM system software. The part geometry data represent the set of parameter definitions or arguments for the MACRO. Accordingly, these automatic routines can be called with a minimum of user interaction.

Profiling and pocketing are two common examples of automatic machining routines that are available on most CAD/CAM systems. The profiling routine is used to generate the sequence of cutter paths for machining around a series of geometry elements which have been identified by the user.

## **APPENDIX: APT WORD DEFINITIONS**

- ATANGL:** At angle (descriptive data). Indicates that the data that follow represent a specified angle. Angle is given in degree.
- CALL:** Call. Used to call a MACRO subroutine and to specify parameter values for the MACRO.
- CENTER:** Center (descriptive data). Used to indicate the center of circle.
- CLPRNT:** Cutter location print (auxiliary statement). Can be used to obtain a computer printout of the cutter location sequence on the NC tape.
- COOLNT:** Coolant (postprocessor statement). Turns coolant on, off, and actuates other coolant options that may be available. Examples: COOLNT/ON COOLNT/OFF COOLNT/FLOOD COOLNT/MIST
- CUTTER:** Cutter (auxiliary statement). Defines cutter diameter to be used in tool offset computations.
- END:** End (postprocessor statement). Used to stop the machine at the end of a section of the program. Can be used to change tools manually. Meaning may vary between machine tools. To continue program, a FROM statement should be used.
- FEDRAT:** Feed rate (postprocessor statement). Used to specify feet rate in inches per minute. FEDRAT/6.0
- FINI:** Finish (auxiliary statement). Must be the last word in the APT program. Used to indicate the end of the complete program.
- FROM:** From the tool starting location (motion startup command). Used to specify the starting point of the cutter, from which other tool movements will be measured.
- GO:** Go (motion startup command in contouring). Used to bring the tool from the starting point against the drive surface, part surface, and check surface.  
GO/TO, LI, TO, PL1, TO,L2  
GO/PAST, L 1 , TO, PL1, ON, TO,L2  
In the statements the initial drive surface is the line L1, the part surface is PL1, and the initial check surface is L2.

GODLTA:	GO delta (PTP motion command). Instructs the tool to move in increments as specified from the current tool location. GODLTA/2.0, 3.0, —4.0
GOBACK:	Go back (contour motion command). Instructs the tool to move back relative to its previous direction of movement. GOBACKJPL5, TO, L1
GODOWN:	GO down (contour motion command).
GOFWD:	Go forward (contour motion command).
GOLFT:	Go left (contour motion command).
GORGT:	Go right (contour motion command).
GOTO:	Go to (PTP motion command). Used to move the tool center to a specified point location. Methods of specification: <ol style="list-style-type: none"> <li>1. By using a previously defined point. GOTO/P1</li> <li>2. By defining the coordinates of the point GOTO/2.0, 5.0, 0.0</li> </ol>
GOUP:	Go up (contour motion command).
INTOF:	Intersection of (descriptive data). Indicates that the intersection of two geometry elements is the specified point.
INTOL:	Inside tolerance (auxiliary statement). Indicates the allowable tolerance between the inside of a curved surface and any straight-line segments used to approximate the curve.
LEFT:	Left (descriptive data). Used to indicate which two alternatives, left or right, is desired.
LINE:	Line (geometry type). Used to define a line that is interpreted by APT as a plane perpendicular to the xy plane.
MACHINE:	Machine (postprocessor statement). Used to specify the machine tool and to call the postprocessor for that machine tool. MACHIN/MILL, 1 In the statement the MILL identifies the machine tool type and 1 identifies the particular machine and postprocessor. The APT system then calls the specified postprocessor to prepare the NC tape for that machine.
MACRO:	Used to subordinate which will be called by the main APT program. DRILL=MACRO/PX When DRILL is the symbol for the subroutine and PX is a parameter in the subroutine whose value will be specified when the subroutine is called from the main program.
ON:	On (motion modifier word) used with three other motion modifier words—TO PAST, and TANTO—to indicate the point on the check surface where the tool motion is to terminate.
OUTTOL:	Outside Tolerance (auxiliary statement). Indicates the allowable tolerance between the outside of a curved surface and any straight-line segments used to approximate the curve.



PARLEL: Parallel (descriptive data). Used to define a line or plane as being parallel to another line or plane.

PARTNO: Part number (auxiliary statement). Used at start of program to identify the part program. PARTNO must be typed in columns I through 6 of the first computer card in the check.

PAST: Past (motion modifier word).

PERPTO: Perpendicular to (descriptive data). Used to define a line of plane as being perpendicular to some other line or plane.

PLANE: Plane (geometry type). Used to define a plane.

POINT: Point (geometry type). Used to define a point.

RADIUS: Radius (descriptive data). Used to indicate the radius of a circle.

RIGHT: Right (descriptive data). *See* LEFT and LINE.

TANTO: Tangent to (two uses: descriptive data and motion modifier word).

TERMAC: Termination of MACRO subroutine. Used as the last statement in the MACRO subroutine to indicate a return to the main program at the statement following the CALL.

TO: To (motion modifier word).

TURRET: Turret (postprocessor statement). Used to specify a turret position on a turret lathe or drill or to call a specific tool from an automatic tool hanger. Example: TURRET/T30.

XLARGE: In the positive x-direction (descriptive data). Used to indicate the relative position of one geometric element with respect to another when there are two possible alternatives.

XSMALL: In the negative x-direction (descriptive data).

YLARGE: In the positive y-direction (descriptive data). *See* XLARGE.

YSMALL: In the negative y-direction (descriptive data). *See* XLARGE.

### 39 COMPUTER NUMERICAL CONTROL

Computer Numerical Control (CNC) is one in which the functions and motions of a machine tool are controlled by means of a prepared program containing coded alphanumeric data. CNC can control the motions of the workpiece or tool, the input parameters such as feed, depth of cut, speed, and the functions such as turning spindle on/off, turning coolant on/off. CNC utilizes a dedicated, stored program computer to perform some or all of the basic numerical control functions. Because of the trend toward downsizing in computers, most of the CNC systems sold today use a microcomputer-based controller unit. Over the years minicomputers have also been used in CNC controls.

The applications of CNC include both for machine tool as well as non-machine tool areas. In the machine tool category, CNC is widely used for lathe, drill press, milling machine, grinding unit, laser, sheet-metal press working machine, tube bending machine etc. Highly automated machine tools such as turning center and machining center which change the cutting tools automatically under CNC control have been developed. In the non-machine tool category, CNC applications include welding machines (arc and resistance), coordinate measuring machine, electronic assembly, tape laying and filament winding machines for composites etc.

#### 3.9.1 Problems with conventional NC

There are a number of problems inherent in conventional NC which have motivated machine tool builders to seek improvements in the basic NC system. Among the difficulties encountered in using conventional numerical control are the following:

1. **Part programming mistakes.** In preparing the punched tape, part programming mistakes are common. The mistakes can be either syntax or numerical errors, and it is not uncommon for three or more passes to be required before the NC tape is correct. Another related problem in part programming is to achieve the best sequence of processing steps. This is mainly a problem in manual part programming. Some of the computer-assisted part programming languages provide aids to achieve the best operation sequences.
2. **No optimal speeds and feeds.** In conventional numerical control, the control system does not provide the opportunity to make changes in speeds and feeds during the cutting process. As a consequence, the programmer must set the speeds and feeds for worst-case conditions. The result is lower than optimum productivity.
3. **Punched tape.** Another problem related to programming is the tape itself. Paper tape is especially fragile, and its susceptibility to wear and tear causes it to be an unreliable NC component for repeated use in the shop. More durable tape materials, such as Mylar, are utilized to help overcome this difficulty. However, these materials are relatively expensive.
4. **Tape reader.** The tape reader that interprets the punched tape is generally acknowledged among NC users to be the least reliable hardware component of the machine. When a breakdown is encountered on an NC machine, the maintenance personnel usually begin their search for the problem with the tape reader.
5. **Controller.** The conventional NC controller unit is hard-wired. This means that its control features cannot be easily altered to incorporate improvements into the unit. Use of a computer as the control device would provide the flexibility to make improvements in such features as circular interpolation when better software becomes available,

6. **Management information.** The conventional NC system is not equipped to provide timely information on operational performance to management. Such information might include piece counts, machine breakdowns, and tool changes.

Machine tool builders and control engineers have been continually improving NC technology by designing systems which help to solve these problems. Much of this improvement has been provided by advances in electronics. In the following section we explore the developments in electronics and solid-state technology which have lead the way in NC controller evolution.

### 3.9.2 Configuration of CNC System

The external appearance of a CNC machine is very similar to that of a conventional NC machine. Part programs are initially entered in a similar manner. Punched tape readers are still the common device to input the part program into the system. However, with conventional numerical control, the punched tape is cycled through the reader for every workpiece in the batch. With CNC, the program is entered once and then stored in the computer memory. Thus the tape reader is used only for the original loading of the part program and data. Compared to regular NC, CNC offers additional flexibility and computational capability. New system options can be incorporated into the CNC controller simply by reprogramming the unit. Because of this reprogramming capacity, both in terms of part programs and system control options, CNC is often referred to by the term "soft-wired" NC. Following figure illustrates the general configuration of a CNC system.

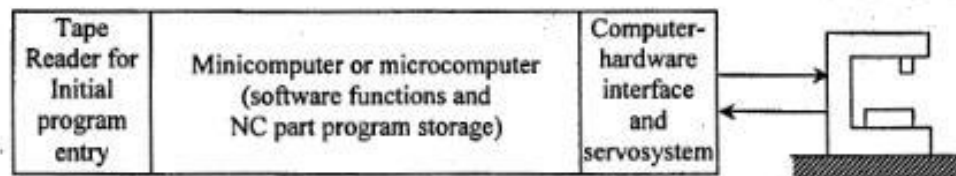

Figure 3.13 General configuration of a CNC System

Generally a CNC system consists of three basic components:

1. Part program
2. Machine Control Unit (MCU)
3. Machine tool (lathe, drill press, milling machine etc)

#### **Part Program**

The part program is a detailed set of commands to be followed by the machine tool. Each command specifies a position in the Cartesian coordinate system (x,y,z) or motion (workpiece travel or cutting tool travel), machining parameters and on/off function. Part programmers should be well versed with machine tools, machining processes, effects of process variables, and limitations of CNC controls. The part program is written manually or by using computer assisted language such as APT.

#### **Machine Control Unit**

The machine control unit (MCU) is a microcomputer that stores the program and executes the commands into actions by the machine tool. The MCU consists of two main units: the data processing unit (DPU) and the control loops unit (CLU). The DPU software includes control system software, calculation algorithms, translation software that converts the part program into a usable format for the MCU, interpolation algorithm to achieve smooth motion of the

cutter, editing of part program (in case of errors and changes). The DPU processes the data from the part program and provides it to the CLU which operates the drives attached to the machine leadscrews and receives feedback signals on the actual position and velocity of each one of the axes. A driver (dc motor) and a feedback device are attached to the leadscrew. The CLU consists of the circuits for position and velocity control loops, deceleration and backlash take up, function controls such as spindle on/off.

### Machine Tool

The machine tool could be one of the following: lathe, milling machine, laser, plasma, coordinate measuring machine etc. Figure 3 shows that a right-hand coordinate system is used to describe the motions of a machine tool. There are three linear axes (x,y,z), three rotational axes (i,j,k), and other axes such as tilt ( $\theta$ ) are possible. For example, a 5-axis machine implies any combination of x,y,z, i,j,k,and  $\theta$ .

### 3.9.3 Functions of CNC

There are a number of functions which CNC is designed to perform. Several of these functions would be either impossible or very difficult to accomplish with conventional NC. The principal functions of CNC are:

1. Machine tool control
2. In-process compensation
3. Improved programming and operating features
4. Diagnostics

### Machine Tool Control

The primary function of the CNC system is control of the machine tool. This involves conversion of the part program instructions into machine tool motion through the computer interface and servo system. The capability to conveniently incorporate a variety of control features into the soft-wired controller unit is the main advantage of CNC. Some of the control functions, such as circular interpolation, can be accomplished more efficiently with hard-wired circuits than with the computer. This fact has led to the development of two alternative controller designs in CNC: **(1) Hybrid CNC, (2) Straight CNC.**

In the hybrid CNC system, illustrated in Figure 3.14, the controller consists of the soft-wired computer plus hard-wired logic circuits. The hard-wired components perform those functions which they do best, such as feed rate generation and circular interpolation. The computer performs the remaining control functions plus other duties not normally associated with a conventional hard-wired controller.

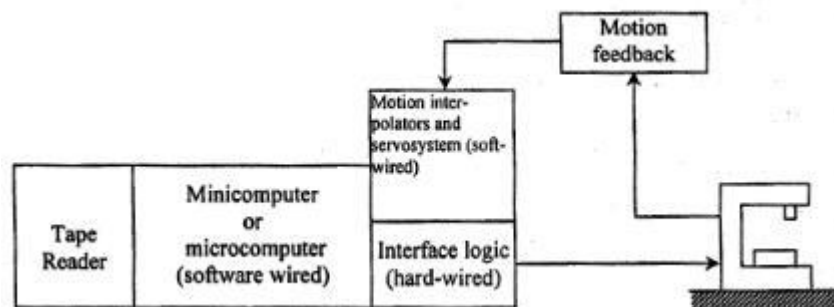

Figure 3.14 Hybrid CNC

There are several reasons for the popularity of the hybrid CNC configuration. As mentioned previously, certain NC functions can be performed more efficiently with the hardwired circuits. These are functions which are common to most NC systems. Therefore, the circuits that perform these functions can be produced in large quantities at relatively low cost. Use of these hardwired circuits saves the computer from performing these calculation chores. Hence a less expensive computer is required in the hybrid CNC controller.

The straight CNC system uses a computer to perform all the NC functions. The only hard-wired elements are those required to interface the computer with the machine tool and the operator's console. Interpolation, tool position feedback, and all other functions are performed by computer software. Accordingly, the computer required in a straight CNC system must be more powerful than that needed for a hybrid system. The advantage gained in the straight CNC configuration is additional flexibility. It is possible to make changes in the interpolation programs, whereas the logic contained in the hard-wired circuits of hybrid CNC cannot be altered. A diagram of the straight CNC designed shown in Figure 3.15.

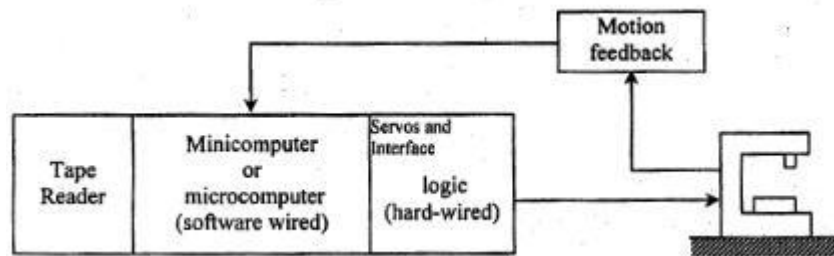

Figure 3.15 Straight CNC

### **In-process compensation**

A function closely related to machine tool control is in-process compensation. This involves the dynamic correction of the machine tool motions for changes or errors which occur during processing. Some of the options included within the category of CNC in-process compensation are:

- Adjustments for errors sensed by in-process inspection probes and gauges.
- Recomputation of axis positions when an inspection probe is used to locate a datum reference on a workpart.
- Offset adjustments for tool radius and length.
- Adaptive control adjustments to speed and/or feed.
- Computation of predicted tool life and selection of alternative tooling when indicated.

### **Improved Program and Operating Features**

The flexibility of soft-wired control has permitted the introduction of many convenient programming and operating features. Included among these features are the following:

- Editing of part programs at the machine. This permits correction or optimization of the program.
- Graphic display of the tool path to verify the tape.
- Various types of interpolation: circular, parabolic, and cubic interpolation.
- Support of both U.S. customary units and metric units (International System)
- Use of specially written subroutines.
- Manual data input (MDI)
- Local storage of more than one part program.

## **Diagnostics**

NC machine tools are complex and expensive systems. The complexity increases the risk of component failures which lead to system down-time. It also requires that the maintenance personnel be trained to a higher level of proficiency in order to make repairs. The higher cost of NC provides a motivation to avoid downtime as much as possible. CNC machines are often equipped with a diagnostics capability to assist in maintaining and repairing the system. These diagnostics features are still undergoing development and future systems will be much more powerful in their capabilities than current CNC units. Ideally, the diagnostics subsystem would accomplish several functions.

- First, the subsystem would be able to identify the reason for a downtime occurrence so that the maintenance personnel could make repairs more quickly.
- Second, the diagnostics subsystem would be alert to signs that indicate the imminent failure of a certain component. Hence maintenance personnel could replace the faulty component during a scheduled downtime, thus avoiding an unplanned interruption of production.
- A third possible function which goes beyond the normal diagnostics capability is for the CNC system to contain a certain amount of redundancy of components which are considered unreliable. When one of these components fails, the diagnostics subsystem would automatically disconnect the faulty component and activate the redundant component. Repairs could thus be accomplished without any breaks in normal operations.

### **3.9.4 Advantages of CNC**

Computer numerical control possesses a number of inherent advantages over conventional NC. The following list of benefits will serve also as a summary of our preceding discussion:

1. **The part program tape and tape reader are used only once** to enter the program into computer memory. This results in improved reliability, since the tape reader is commonly considered the least reliable component of a conventional NC system.
2. **Tape editing at the machine site.** The NC can be corrected and even optimized (i.e., tool path, speeds, and feeds) during tape tryout at the site of the machine tool.
3. **Metric conversion.** CNC can accommodate conversion of tapes prepared in units of inches into the International System of units.
4. **Greater flexibility.** One of the more significant advantages of CNC over conventional NC is its flexibility. This flexibility provides the opportunity to introduce new control options (e.g., new interpolation schemes) with relative ease at low cost. The risk of obsolescence of the CNC system is thereby reduced.
5. **User-written programs.** One of the possibilities not originally anticipated for CNC was the generation of specialized programs by the user. These programs generally take the form of MACRO subroutines stored in CNC memory which can be called by the part program to execute frequently used cutting sequences.
6. **Total manufacturing system.** CNC is more compatible with the use of a computerized factory-wide manufacturing system. One of the stepping stones toward such a system is the concept of direct numerical control.

### 3.10 DIRECT NUMERICAL CONTROL

Direct numerical control can be defined as a manufacturing system in which a number of machines are controlled by a computer through direct connection and in real time. The tape reader is omitted in DNC, thus relieving the system of its least reliable component. Instead of using the tape reader, the part program is transmitted to the machine tool directly from the computer memory. In principle, one large computer can be used to control more than 100 separate machines. The DNC computer is designed to provide instructions to each machine tool on demand. When the machine needs control commands, they are communicated to it immediately. DNC also involves data collection and processing from the machine tool back to the computer.

#### 3.10.1 Components of a DNC system

Figure illustrates the configuration of the basic DNC system. A direct numerical control system consists of four basic components:

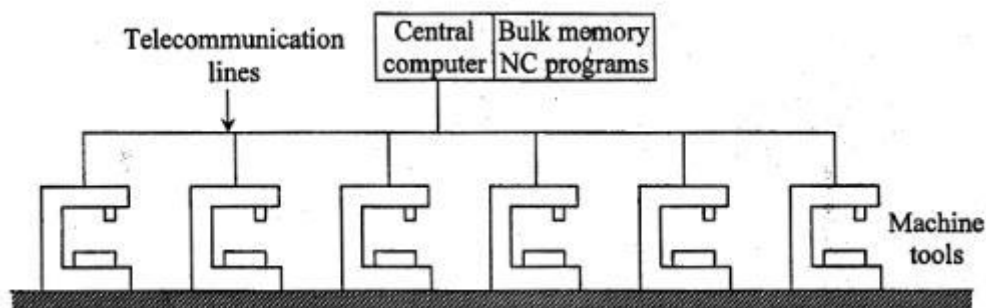

Figure 3.16 General configuration of a DNC system

1. Central computer
2. Bulk memory, which stores the NC part programs
3. Telecommunication lines
4. Machine tools

The computer calls the part program instructions from bulk storage and sends them to the individual machines as the need arises. It also receives data back from the machines. This two-way information flow occurs in real time, which means that each machine's requests for instructions must be satisfied almost instantaneously. Similarly, the computer must always be ready to receive information from the machines and to respond accordingly. The remarkable feature of the DNC system is that the computer is servicing a large of separate machine tools, all in real time.

Depending on the number of machines and the computational requirements that are imposed on the computer, it is sometimes necessary to make use of satellite computers, as shown in figure. These satellites are minicomputers, and they serve to take some of the burden off the central computer. Each satellite controls several machines. Groups of part program instructions are received from the central computer and stored in buffers. They are then dispensed to the individual machines as required. Feedback data from the machines are also stored in the satellite's buffer before being collected at the central computer.

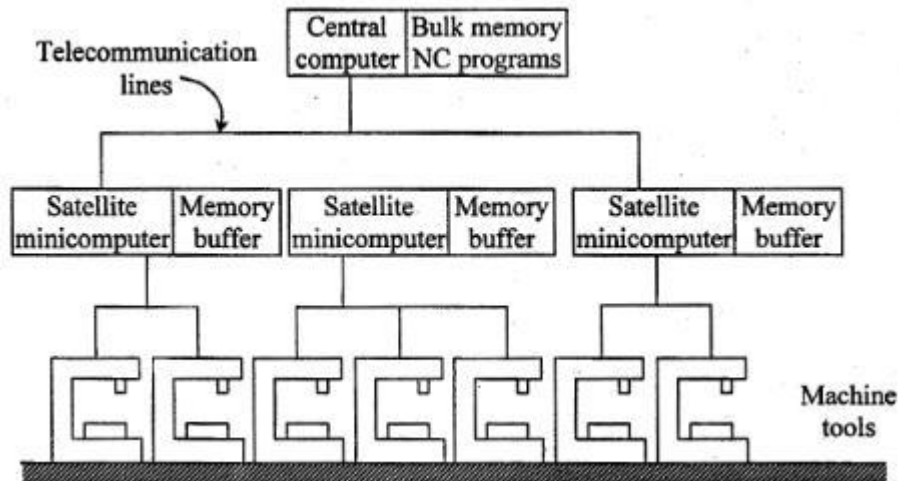

Figure 3.17 DNC with satellite minicomputer

### 3.10.2 Two types of DNC

There are two alternative system configurations by which the communication link is established between the control computer and the machine tool. One is called a behind-the-tape reader system; the other configuration makes use of a specialized machine control unit.

#### Behind-the-tape-reader (BTR) system

In this arrangement, pictured in figure, the computer linked directly to the regular NC controller unit. The replacement of the tape reader by the telecommunication lines to the DNC computer is what gives the BTR configuration its name. The connection with the computer is made between the tape reader and the controller unit-behind the tape reader.

Except for the source of the command instructions, the operation of the system is very similar to conventional NC. The controller unit uses two temporary storage buffers to receive blocks of instructions from the DNC computer. The replacement of the tape reader by the telecommunication lines to the DNC computer is what gives the BTR configuration its name. The connection with the computer is made between the tape reader and the controller unit-behind the tape reader.

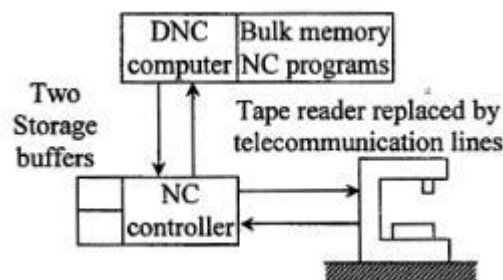

Figure 3.18 DNC with BTR configuration

#### Special Machine control unit

The other strategy in DNC is to eliminate the regular NC controller altogether and replace it with a special machine control unit. The configuration is illustrated in figure. This special MCU is a device that is specifically designed to facilitate communication between the machine tool and the computer. One area where this communication link is important is in circular interpolation of the cutter path. The special MCU configuration achieves a superior



balance between accuracy of the interpolation and fast metal removal rates than is generally possible with the BTR system.

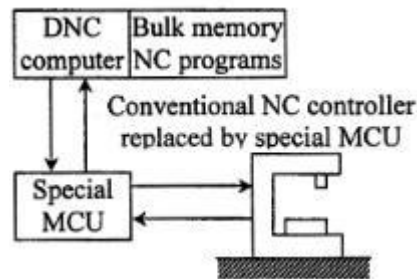

Figure 3.19 DNC with special MCU configuration

The special MCU is soft-wired, the conventional NC controller is hard-wired. The advantage of soft-wiring is its flexibility. Its control functions can be altered with relative ease to make improvements. It is much more difficult to make changes in the regular NC controller because rewiring required.

At present, the advantage of the BTR configuration is that its cost is less, since only minor changes are needed in the conventional NC system to bring DNC into the shop. BTR systems do not require the replacement of the conventional control unit by a special MCU. However, this BTR advantage is a temporary one, since most NC machines are sold with computer numerical control. The CNC controller serve much the same purpose as a special MCU when incorporated into a DNC system.

### **3.10.3 Functions of DNC**

There are several functions which a DNC system is designed to perform. These functions are unique to DNC and could not be accomplished with either conventional NC or CNC. The principal functions of DNC are:

1. NC without punched tape
2. NC part program storage
3. Data collection, processing, and reporting
4. Communications

**NC without punched tape.** One of the original objectives in direct numerical control was to eliminate the use of punched tape. Several of the problems with conventional NC discussed earlier are related to the use of punched tape (the relatively unreliable tape reader, the fragile nature of paper tape, the difficulties in making corrections and changes in the program contained on punched tape, *etc.*). There is also the expense associated with the equipment that produces the punched tape. All of these costs and inconveniences can be eliminated with the DNC approach.

**NC part program storage.** A second important function of the DNC system is concerned with storing the part programs. The program storage subsystem must be structured to satisfy several purposes. First, the programs must be made available for downloading to the NC machine tools. Second, the subsystem must allow for new programs to be entered, old programs to be deleted, and existing programs to be edited as the need arises. Third, the DNC software must accomplish the post-processing function. The part programs in a DNC system would typically be stored as the CLIFILE. The CLFILE must be converted into instructions for a particular machine tool. This conversion is performed by the post-processor. Fourth, the

storage subsystem must be structured to perform certain data processing and management functions, such as file security, display of programs, manipulation of data, and so on.

The DNC program storage subsystem usually consists of an active storage and a secondary storage. The active storage would be used to store NC programs which are frequently used. A typical mass storage device for this purpose would be a disk. The active storage can be readily accessed by the DNC computer to drive an NC machine in production. The secondary storage would be used for NC programs which are not frequently used. Sometimes, even though it is anticipated that a particular program will probably never be used again, it may be decided to save that program if the storage costs are not excessive. Examples of secondary storage media used in DNC include magnetic tape, tape cassettes, floppy disks, disks packs, and even punched tape. (Unfortunately, the last alternative resurrects the several disadvantages mentioned earlier.)

**Data collection, processing and reporting.** The two previous functions for DNC both concerned the direct link from the central computer to the machine tools in the factory. Another important function of DNC involves the opposite link, the transfer of data from the machine tools back to the central computer. DNC involves a two-way transfer of data.

The basic purpose behind the data collection, processing, and reporting function of DNC is to monitor production in the factory. Data are collected on production piece counts, tool usage, machine utilization, and other factors that measure performance in the shop. These data must be processed by the DNC computer, and reports are prepared to provide management with information necessary for running the plant. The scope of this DNC function has been broadened over the years to include data collection not only from the NC machines, but from all other work centres in the factory. The term used to describe this broader scope activity is shop floor control.

**Communications.** A communications network is required to accomplish the previous three functions of DNC. Communication among the various subsystems is a function that is central to the operation of any DNC system. The essential communication links in direct numerical control are between the following components of the system:

- Central computer and machine tools
- Central computer and NC part programmer terminals
- Central computer and bulk memory, which stores the NC programs

#### **3.10.4 Advantages of DNC**

Just as CNC had certain advantages over a conventional NC system, there are also advantages associated with the use of direct numerical control. The following list will recapitulate much of our previous discussion of DNC:

1. **Elimination of punched tapes and reader.** Direct numerical control eliminates the least reliable element in the conventional NC system. In some DNC systems, the hard-wired control unit is also eliminated, and replaced by a special machine control unit designed to be more compatible with DNC operation.
2. **Greater computational capability and flexibility.** The large DNC computer provided the opportunity to perform the computational and data processing functions more effectively than traditional and data processing functions more effectively than traditional NC. Because these functions are implemented with software rather than with hard-wired devices, there exists the flexibility to alter and improve the method by which these functions are carried out. Examples of these functions include circular

interpolation and part programming packages with convenient editing and diagnostics features.

3. **Convenient storage of NC part programs in computer files.** This compares with the more manually oriented storage of punched tapes in conventional NC.
4. **Programs stored as CLFILE.** Storage of part programs in DNC is generally in the form of cutter path data rather than post-processed programs for specific machine tools. Storing of the programs in this more general format affords the flexibility in production scheduling to process a job on any of several different machine tools.
5. **Reporting of shop performance.** One of the important features in DNC involves the collection, processing, and reporting of production performance data from the NC machines.
6. **Establishes the framework for the evolution of the future computer automated factory.** The direct numerical control concept represents a first step in the development of production plants which will be managed by computer systems.

### 311 ADAPTIVE CONTROL SYSTEMS

For a machining operation, the term *adaptive control* denotes a control system that measures certain output process variables that have been used in adaptive control machining systems include spindle deflection or force, torque, cutting temperature, vibration amplitude, and horsepower. In other words, nearly all the metal cutting variables that can be measured have been tried in experimental adaptive control systems. The motivation for developing an adaptive machining system lies in trying to operate the process more efficiently. The typical measures of performance in machining have been metal removal rate and cost per volume of metal removed.

#### **Where to use adaptive control**

One of the principal reasons for using numerical control (including DNC and CNC) is that NC reduces the non-productive time in a machining operation. This time savings is achieved by reducing such elements as work piece handling time, setup of the job, tool changes, and other sources of operator and machine delay. Because these non-productive elements are reduced relative to total production time, a larger proportion of the time is spent in actually machining the work part. Although NC has a significant effect on downtime, it can do relatively little to reduce the in process time compared to a conventional machine tool. The most promising answer for reducing the in process time lies in the use of adaptive control. Whereas numerical control guides the sequences of tool positions or the path of the tool during machining, adaptive control determines the proper speeds and/or feeds during machining as a function of variations in such factors as work-material hardness, width or depth of cut, air gaps in the part geometry, and so on. Adaptive control has the capability to respond to and compensate for these variations during the process. Numerical control does not have this capability.

Adaptive control (AC) is not appropriate for every machining situation. In general, the following characteristics can be used to identify situations where adaptive control can be beneficially applied:

1. The in-process time consumes a significant portion of the machining cycle time.
2. There are significant sources of variability in the job for which adaptive control can compensate. In effect, AC adapts feed and/or speed to these variables conditions.
3. The cost of operating the machine tool is high. The high operational cost results mainly from the high investment in equipment.

4. The typical jobs are ones involving steel, titanium, and high-strength alloys. Cast iron and aluminium are also attractive candidates for AC, but these materials are generally easier to machine.

### **3.11.1 Source of variability in machining**

The following are the typical sources of variability in machining where adaptive control can be most advantageously applied. Not all of these sources of variability need be present to justify the use of AC. However, it follows that the greater the variability, the more suitable the process will be for using adaptive control.

1. **Variable geometry of cut in the form of changing depth or width of cut.** In these cases, feed rate is usually adjusted to compensate for the variability. This type of variability is often encountered in profile milling or contouring operations.
2. **Variable work piece hardness and variable machinability.** When hard spots or other areas of difficulty are encountered in the work-piece either speed or feed is reduced to avoid premature failure of the tool.
3. **Variable work piece rigidity.** If the work piece deflects as a result of insufficient rigidity in the setup, the feed rate must be reduced to maintain accuracy in the process.
4. **Tool wear.** It has been observed in research that as the tool begins to dull, the cutting forces increase. The adaptive controller will typically respond to tool dulling by reducing the feed rate.
5. **Air gaps during cutting.** The work-piece geometry may contain shaped sections where no machining needs to be performed. If the tool were to continue feeding through these so-called air gaps at the same rate, time would be lost. Accordingly, the typical procedure is to increase the feed rate by a factor of 2 or 3, when air gaps are encountered.

These sources of variability present themselves as time varying and, for the most part, unpredictable changes in the machining process.

### **3.11.2 Two types of adaptive control**

In the development of adaptive control machining system, two distinct approaches to the problem can be distinguished. These are:

1. Adaptive control optimization (ACO)
  2. Adaptive control constraint (ACC)
1. **Adaptive control optimization.** This is represented by the early Bendix research on adaptive control machining. In this form of adaptive control, an index of performance is specified for the system. This performance index is a measure of overall process performance, such as production rate or cost per volume of metal removed. The objective of the adaptive controller is to optimize the index of performance by manipulating speed and/or feed in the operation.
  2. **Adaptive control constraint.** The systems developed for actual production were somewhat less sophisticated (and less expensive) than the research ACO systems. The production AC systems utilize constraint limits imposed on certain measured process variables. Accordingly, these are called adaptive control constraint (ACC) systems. The objective in these systems is to manipulate feed and/or speed so that these measured process variables are maintained at or below their constraint limit values. The following subsection describes the operation of the most common commercially available ACC system.

### **3.11.3 Operation of an ACC system**

Typical applications of adaptive control machining are in profile or contour milling jobs on an NC machine tool. Feed is used as the controlled variable, and cutter force and horsepower are used as the measured variables. It is common to attach an adaptive controller to an NC machine tool. Numerical control machines are a natural starting point for AC for two reasons. First, NC machine tools often possess the required servomotors on the table axes to accept automatic control. Second, the usual kinds of machining jobs for which NC is used possess the sources of variability that make AC feasible. Several large companies have retrofitted their NC machines to include adaptive control. The adaptive control retrofit package consists of a combination of hardware and software components. The typical hardware components are:

1. Sensors mounted on the spindle to measure cutter deflection (force).
2. Sensors to measure spindle to motor current. This is used to provide an indication of power consumption.
3. Control unit and display panel to operate the system.
4. Interface hardware to connect the AC system to the existing NC or CNC control unit.

The software in the AC package consists of a machinability program which can be called as an APT MACRO statement. The relationship of the machinability program in the part programming process is shown in Figure 3.20. The inputs to the program include cutting parameters such as cutter size and geometry, work material hardness, size of cut, and machine tool characteristics. From calculations based on these parameters, the outputs from the program are feed rates, spindle speeds, and cutter force limits for each section of the cut. The objective in these computations is to determine cutting conditions which will maximize metal removal rates. The NC part programmer would ordinarily have to specify feeds and speeds for the machining job. With adaptive control, these conditions are computed by the machinability program based on the input data supplied by the part programmer.

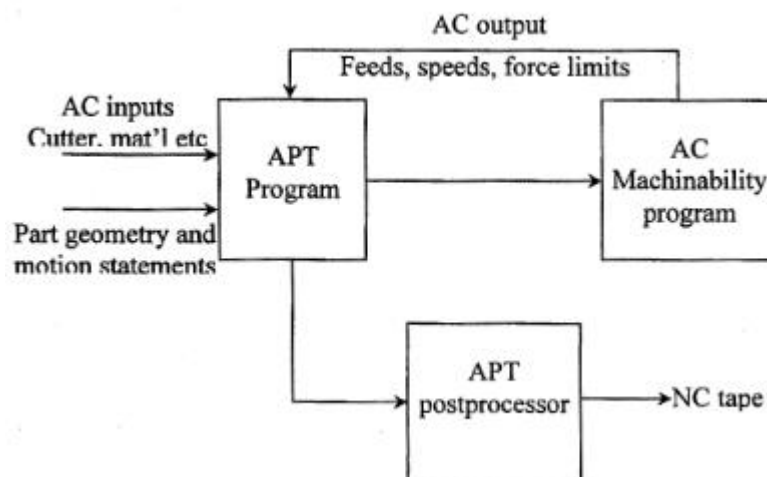

Figure 3.20 Relationship of adaptive control (AC) software to APT program

In machining, the AC system operates at the force value calculated for the particular cutter and machine tool spindle. Maximum production rates are obtained by running the machine at the highest feed rate consistent with this force level. Since force is dependent on such factors as depth and width of cut, the end result of the control action is to maximize metal removal rates within the limitations imposed by existing cutting conditions.

Figure 3.21 shows a schematic diagram illustrating the operation of the AC system during the machining process. When the force increases due to increased work piece hardness or depth or width of cut, the feed rate is reduced to compensate. When the force decreases, owing to decreases in the foregoing variables or air gaps in the part, feed rate is increased to maximize the rate of metal removal.

Figure 3.21 shows an air-gap override feature which monitors the cutter force and determines if the cutter is moving through air or through metal. This is usually sensed by means of a low threshold value of cutter force. If the actual cutter force is below this threshold level, the controller assumes that the cutter is passing through an air gap. When an air gap is sensed, the feed rate is doubled or tripled to minimize the time wasted travelling across the air gap. When the cutter reengages metal on the other side of the gap, the feed reverts back to the cutter force mode of control.

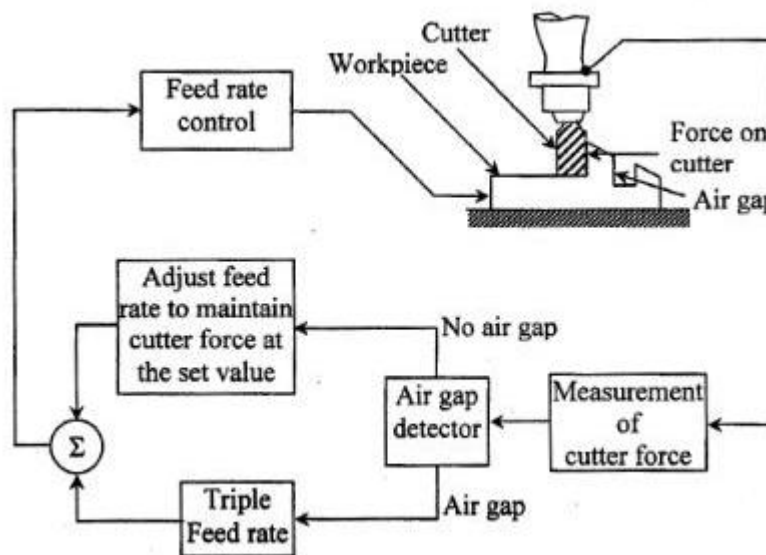

Figure 3.21 Configuration of typical adaptive control machining system that uses cutter forces as the measured process variable

### 3.11.4 Benefits of adaptive control machining

A number of potential benefits accrue to the user of an adaptive control machine tool. The advantage gained will depend on the particular job under consideration. There are obviously many machining situations for which it cannot be justified. Adaptive control has been successfully applied in such machining processes as milling, drilling, tapping, grinding, and boring. It has also been applied in turning, but with only limited success. Following are some of the benefits gained from adaptive control in the successful applications.

1. **Increased production rates.** Productivity improvement was the motivating force behind the development of adaptive control machining. On-line adjustments to allow for variations in work geometry, material, and tool wear provide the machine with the capability to achieve the highest metal removal rates that are consistent with existing cutting conditions. This capability translates into more parts per hours. Given the right application, adaptive control will yield significant gains in production rate compared to conventional machining or numerical control. The production rate advantage of adaptive control over NC machining is illustrated in Table for milling and drilling operations on a variety of work materials. Savings in cycle time reported in this table range from 20% up to nearly 60% for milling and 33 to 38% for drilling.

2. **Increased tool life.** In addition to higher production rates, adaptive control will generally provide a more efficient and uniform use of the' cutter throughout its tool life. Because adjustments are made in the feed rate to prevent severe loading of the tool, fewer cutters will be broken.
3. **Greater part protection.** Instead of setting the cutter force constraint limit on the basis of maximum allowable cutter and spindle deflection, the force limit can be established on the basis of work size tolerance. In this way, the part is protected against an out-of-tolerance condition and possible damage.
4. **Less operator intervention.** The advent of adaptive control machining has transferred control over the process even further out of the hands of the machine operator and into the hands of management via the part programmer.
5. **Easier part programming.** A benefit of adaptive control which is not so obvious concerns the task of part programming. With ordinary numerical control, the programmer must plan the speed and feed for the worst conditions that the cutter will encounter. The program may have to be tried out several times before the programmer is satisfied with the choice of conditions. In adaptive control part programming, the selection of feed is left to the controller unit rather than to the part programmer. The programmer can afford to take a less conservative approach than with conventional NC programming. Less time is needed to generate the program for the job, and fewer tryouts are required.

## **APPENDICES**

### **Appendix-I: ISO Standards for Coding**

In the early years of development of Numerical Control standardization has been given due importance. As a result many of the things that we use in NC are standardized and many of the manufacturers. Follow the standards to a great extent. One of the first things to be standardized is the work addresses to be used in programming. All the 26 letters of the English alphabet was standardized and given meaning as follows:

<b>Character</b>	<b>Address For</b>
A	Angular dimension around X axis
B	Angular dimension around Y axis
C	Angular dimension around Z axis
D	Angular dimension around special axis or third feed function*
E	Angular dimension around special axis or second feed function*
F	Feed function
G	Preparatory function
H	Unassigned
I	Distance to arc centre or thread lead parallel to X
J	Distance to arc centre or thread lead parallel to Y
K	Distance to arc centre or thread lead parallel to Z
L	Do not use
M	Miscellaneous function
N	Sequence number
O	Reference rewind stop
P	Third rapid traverse dimension or tertiary motion dimension parallel to X*

Q	Second rapid traverse dimension or tertiary motion dimension parallel to Y*
R	First rapid traverse dimension or tertiary motion dimension parallel to Z*
S	Spindle speed function
T	Tool function
U	Secondary motion dimension parallel to X*
V	Secondary motion dimension parallel to Y*
W	Secondary motion dimension parallel to Z*
X	Primary X motion dimension
Y	Primary Y motion dimension
Z	Primary Z motion dimension

### **Appendix-II: Preparatory Functions**

This is denoted by 'G'. It is a pre-set function associated with the movement of machine axes and the associated geometry. As discussed earlier, it has two digits, e.g. G01, G42, and G90 as per ISO specifications. However, some of the current day controllers accept upto 3 or 4 digits. ISO has standardized a number of these preparatory functions popularly called as G codes. The standardized codes are shown below:

<b>CODE</b>	<b>FUNCTION</b>
G00	Point-to-point positioning, rapid traverse
G01	Line interpolation
G02	Circular interpolation, clockwise (WC)
G03	Circular interpolation, anti-clockwise (CCW)
G04	Dwell
G05	Hold/Delay
G06	Parabolic interpolation
G07	Unassigned
G08	Acceleration of feed rate
G09	Deceleration of feed rate
G10	Linear interpolation for "long dimensions" (10 inches-100 inches)
G11	Linear interpolation for "short dimensions" (up to 10 inches)
G12	Unassigned
G13-G16	Axis designation
G17	XY plane designation
G18	ZX plane designation
G19	YZ plane designation
G20	Circular interpolation, CW for "long dimensions"
G21	Circular interpolation, CW for "short dimensions"
G22-G29	Unassigned
G30	Circular interpolation, CCW for "long dimensions"
G31	Circular interpolation, CCW for "short dimensions"
G32	Unassigned
G33	Thread cutting, constant lead
G34	Thread cutting, linearly increasing lead
G35	Thread cutting, linearly decreasing lead



G36-G39	Unassigned
G40	Cutter compensation-cancels to zero
G41	Cutter radius compensation-offset left
G42	Cutter radius compensation-offset right
G43	Cutter compensation-positive
G44	Cutter compensation-negative
G45-G52	Unassigned
G53	Deletion of zero offset
G54-G59	Datum point/zero shift
G60	Target value, positioning tolerance 1
G61	Target value, positioning tolerance 2, or loop cycle
G62	Rapid traverse positioning
G63	Tapping cycle
G64	Change in feed rate or speed
G65-G69	Unassigned
G70	Dimensioning in inch units
G71	Dimensioning in metric units
G72-G79	Unassigned
G80	Canned cycle cancelled
G81-G89	Canned drilling and boring cycles
G90	Specifies absolute input dimensions
G91	Specifies incremental input dimensions
G92	Programmed reference point shift
G93	Unassigned
G94	Feed rate/min (inch units when combined with G70)
G95	Feed rate/rev (metric units when combined with G71)
G96	Spindle feed rate for constant surface feed
G97	Spindle speed in revolutions per minute
G98-G99	Unassigned

### **Appendix-III: Miscellaneous Functions**

These functions actually operate some controls on the machine tool and thus affect the running of the machine. Generally only one-M codes to be given in a single block. However, some controllers allow for two or more M codes to be given in a block, provided these are not mutually exclusive, e.g., coolant ON (M07) and OFF (M09) cannot be given in one block.

Less number of M codes have been standardized by ISO compared to G codes in view of the direct control exercised by these on the machine tool. The ISO standard M codes are shown below:

<b>CODE</b>	<b>FUNCTION</b>
M00	Program stop, spindle and coolant off
M01	Optional programmable stop
M02	End of program-often interchangeable with M30
M03	Spindle on, CW
M04	Spindle on, CCW
M05	Spindle stop

M06	Tool change
M07	Coolant supply No. 1 on
M08	Coolant supply No. 2 on
M09	Coolant off
M10	Clamp
M11	Unclamp
M12	Unassigned
M13	Spindle on, CW + coolant on
M14	Spindle on, CCW + coolant on
M15	Rapid traverse in + direction
M16	Rapid traverse in — direction
M17 - M18	Unassigned
M19	Spindle stop at specified angular position
M20 — M29	Unassigned
M30	Program stop at end tape + tape rewind
M31	Interlock by-pass
M32 — M35	Constant cutting velocity
M36 - M39	Unassigned
M40 — M45	Gear changes; otherwise unassigned
M46 — M49	Unassigned
M50	Coolant supply No. 3 on
M51	Coolant supply No. 4 on
M52 — M54	Unassigned
M55	Linear cutter offset No. 1 shift
M56	Linear cutter offset No. 2 shift
M57 — M59	Unassigned
M60	Piece part change
M61	Linear piece part shift, location 1
M62	Linear piece part shift, location 2
M63 — M67	Unassigned
M68	Clamp piece part
M69	Unclamp piece part
M70	Unassigned
M71	Angular piece part, shift, location 1
M72	Angular piece part, shift, location 2
M73 — M77	Unassigned
M78	Clamp non-activated machine bed-ways
M79	Unclamp non-activated machine bed-ways
M80- M99	Unassigned

Handling of materials is an integral part of the production process. It involves piling, loading, unloading and transporting parts or raw materials from one place to another. Starting from the point, the raw material enters the factory gate and goes out of the factory in the form of finished products it is handled at all stages in between, from the stores to shop, from one shop to another or from one machine to another on the shop floor. Thus, Material handling may be defined as the handling of raw-materials, semi-finished parts and finished products, mechanically or manually through the production as well as storage areas. The movement may be horizontal, vertical or the combination of horizontal and vertical.

A large part of the indirect labour employed in manufacturing plant is engaged in the handling of materials. It has been estimated that average material handling cost is roughly 20 to 25 percent of the total production cost. It thus becomes clear that the cost of production of an item can be lowered considerably by making a saving in material handling cost.

#### **4.1 Functions of Material Handling**

- i. The movement and positioning of purchased materials, tools, spares etc. for the purpose of storage.
- ii. The internal transportation of materials from stores to shops or departments.
- iii. The movement of materials within departments from one machine to another while processing; and from one department to another,
- iv. The movement and positioning of finished products or components for the purpose of stocking or sale.
- v. Unloading raw-materials from trucks or other transport.
- vi. Loading packed materials on motor trucks or other transport.

#### **4.2 Factors to be considered in Material Handling Problems**

The two most important factors for analyzing or solving material handling problems are:

- a. Engineering factors, and
- b. Economic factors.

##### **Engineering factors**

**1. Nature of Materials and Products to be handled.** The nature of the raw-materials, materials in process, quantities to be handled and distances travelled by them should be considered. The state of the raw material solid, liquid, gaseous, its size, shape, weight and quantity involved mainly governs the type of material handling equipments. A flexible, safe material handling system is developed considering these factors, fragility and bulk of materials involved.

**2. Production Processes and Equipment.** The production process selected, sequence of operations, quantities of materials involved should be considered while designing the material handling system. Different machines have different output per unit time. The material handling equipment selected should be able to handle the maximum output.

**3. Building Construction.** Usually, once a building has been erected, it is not possible, at a reasonable cost, to make too many changes in the construction merely for the purpose of installing material handling equipment. Building construction enters into the problem in respect of:

- (i) If the building is more than one storey, it may involve a question of vertical transportation. A vertical flow pattern will require elevators, conveyors, pipes etc.

while the horizontal flow pattern in single storey building may need trucks, overhead bridge cranes, conveyors etc.

(ii) Secondly, building construction is concerned with the loading that the floors can safely withstand (strength of floors) and also with the possibility of attaching certain types of conveying equipment to the structural members.

(iii) The various features of building, the door locations and sizes, ceiling heights, roof strength, stair columns and width of aisles etc.

Thus the type of building (single or multi-storied), strength of floors and other parts and the various features of building as discussed above are the important considerations in material handling determinations.

**4. Layout.** Layout and material handling are not separable problems. It is necessary that they be considered together. It is possible to make a layout that would be very wasteful of space and perhaps impose other restrictions, and yet it might possibly make most economical form of material handling. Conversely, it is possible to make a layout that utilizes the existing building in the most efficient way and yet makes material handling problems almost impossible of solution. Therefore, in any design of new buildings or the re-arrangement or reconstruction of old buildings, it is essential that layout and material handling be considered jointly.

**5. Existing Material Handling Equipment.** The usefulness and effectiveness of existing material handling equipment is evaluated from its performance of handling different products. If found necessary, additional material handling equipments are installed/provided or necessary changes in the existing equipments may be made in the light of economic benefits availed from such changes.

**6. Production Planning and Control.** The routing and scheduling functions of the production planning and control are closely related to the material handling services. The routing prescribes the sequence for the flow of materials during the processing while the scheduling decides timing of the processing.

**7. Packaging.** The handling of materials during the processing is facilitated through the pallets, while the finished products are packed in the specific containers. Generally wooden boxes, card board, cartons etc. are used for packaging the finished products. The packing of the finished products should be of convenient size so that they can be handled easily.

### **Economic Factors**

For economic analysis while selecting material handling equipment following cost factors must be taken into consideration. Initial cost of equipment, cost of installation, rearrangement of the present equipment, cost of alternation necessary to the building, cost of maintenance, repairs, supplies etc., cost of power, depreciation, cost of labour to operate, cost of any necessary auxiliary equipment, space required, etc. A material handling equipment with the lowest prospective cost is selected. A material handling system is said to be economical if the cost of handling per unit weight of the material for a particular movement is minimum. Economy in material handling can be achieved by:

- employing gravity feed movements
- minimizing distance of travel
- By using a system in which the product from the machine directly falls over material handling equipment (*e.g.* by means of chute or conveyor) and carried to destination without any manual labour.

- Proper periodic inspection, repairs and maintenance etc.

### 4.3 Principles of Material Handling

**1. Reduction in handling.** The first principle of material handling is to minimize the material handling as far as possible. The materials should be moved as little as possible. The selection of production machinery and the type of plant layout should be such that material handling may be eliminated as far as possible. Layout improvement or changes in the process may make it possible to reduce material handling. Factors that are involved in reduction in handling are thus:

- (i) Process changes
- (ii) Layout improvement
- (iii) Increased size of units handled.
- (iv) Use of proper equipment.

**2. Reduction in time.** Time lost reduces the rate of output and increases unit overhead costs. Therefore the time of each move should be minimized. Time is consumed principally in three things:

- (i) *Waiting.* Waiting time may be reduced by proper scheduling, well organisation of labour force, providing proper or sufficient facilities for loading, removing congestion in the plant.
- (ii) *Loading and unloading.* The larger the units loaded or unloaded the greater the reduction that can be made in loading time. The greater the use of mechanical means (hoists, cranes etc.) more efficient can be loading and unloading and faster will be the movement of materials.
- (iii) *Travel time.* A great deal of time can be saved by proper routing or through selection of shortest routes.

**3. Principle of "Unit Load".** According to this principle, the materials should be moved in lots rather than on individual basis. Optimum number of pieces should be moved in one unit to utilize the material handling equipment effectively. The concept of containerization and palletization is applied in deciding the unit load. The principle of unit load avails the economies in the form of reduced loading and unloading labour cost, packing cost, elimination of damage and pilferage, saving in time and effective utilization of material handling equipment.

**4. Use of Gravity.** Wherever possible utilize gravity for assisting material movements as it is the cheapest source of motive power.

**5. Safety.** Safe, standard, efficient, effective, appropriate and flexible material handling equipment should be used.

**6. Use of containers.** Design containers, pallets, drums etc. to reduce the cost of handling and damage of material in transit.

**7. Standby facility.** The provision of stand by facilities should be made so that the sudden break down may not stop the operations due to non-availability of materials.

**8. Periodical Check up.** The check up repairing and maintenance of the existing material handling equipments should be made periodically.

**9. Avoid interference with production line.** The material handling services should not interfere with the production line.

**10. Flexibility.** The material handling services should be evaluated periodically and necessary changes should be incorporated whenever it is possible.

#### 4. 4 Material Handling Devices

A material handling equipment is not a production machinery, but is an auxiliary equipment that improves the flow of materials which in turn reduces stoppages introduction machines and thus increases productivity. Material handling devices are of three types:

- (a) Lifting and lowering devices (vertical movement).
- (b) Transporting devices (horizontal movement)
- (c) Devices which lift and transport (combination devices).

**Lifting and lowering devices:** These devices are used for lifting and lowering the material in a vertical direction only (up & down). These are:

**1. Block and tackle.** (Fig. 1) Block and tackle is one of the oldest and simplest methods of lifting something through a vertical distance. It depends in general on manpower and gives only the mechanical advantage that is possible for the various rope formations. It is crudest, simplest form of lifting, the most inexpensive in cost, and the most wasteful of manpower. It is the device that effect vertical motion by winding the rope or cable on a drum.



Fig. 1 Block and tackle

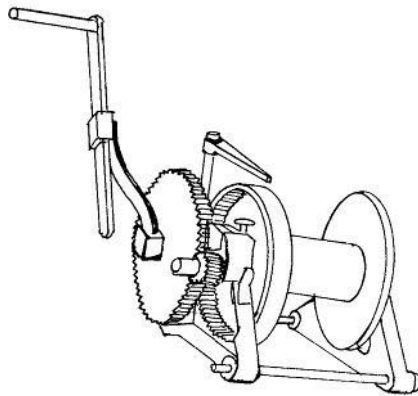

Fig. 2 Winches

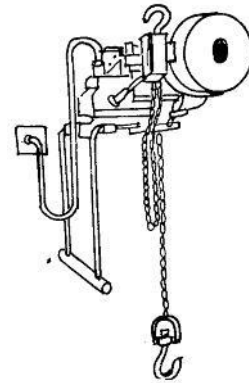

Fig. 3 Power Hoist

**2. Winches.** (Fig. 2) Winches are frequently used in loading heavy equipment into ships, construction equipment into building, and in similar jobs.

**3. Hoists.** Hoists are used for lifting the load vertically. They may be fixed in one place, attached to crane, mounted on monorail trolleys or on a single rail as shown in Fig. 3. The simplest type is the chain hoist which is operated by hand. But hoists operated by compressed air or by electric power are most common.

**4. Elevator.** These are differentiated from hoists by the fact that the operator rides with the load. There are many different types of drives for such elevators, but in general electrical drive is most common. Hydraulic elevators are used only where it is dangerous to take the chance of an electric spark, as in acetylene generator houses.

**5. Winch.** It is used to lift loads by using the rope or a cable on a drum. It is used in loading heavy equipment into ships, construction equipment for buildings and in similar jobs.

**6. Cranes.** Cranes are used to move materials vertically and laterally in an area of limited length. They may be operated hydraulically, pneumatically or electrically, the important types of cranes are:

*Pillar crane.* (Fig. 4) A pillar crane may be stationary type or mobile types. It is used for light duty and for lifting loads up to 20 tonnes. All movements to the crane are provided by gearing and electric motor drive.

*Overhead bridge crane.* Overhead bridge crane is shown in Fig. 5. It has both transverse and longitudinal movements. The crane hook thus moves in a rectangular area can reach to any part of rectangular floor or yard. It is used in foundry, power house, chemical plants, heavy fabrication industry, steel industry etc.

*Gantry Crane.* A gantry crane shown in Fig. 6 acts as an auxiliary to bridge crane. It is provided with wheels and can be moved from one place to another as per requirements.

*Jib Crane.* Fig. 7 shows a jib crane. In this type of crane, the hook can move in a circular path. A jib crane is preferred where lifting of the jobs is required in few locations only or where bridge crane cannot be erected. In a jib crane the hoist unit may be mounted on an I-section jib which is in turn supported on a column.

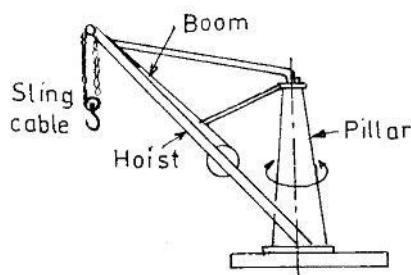

Fig. 4 Pillar Crane

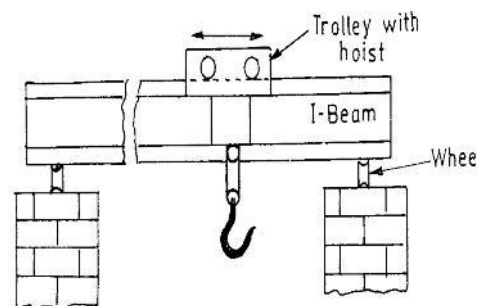

Fig. 5 Overhead Bridge crane

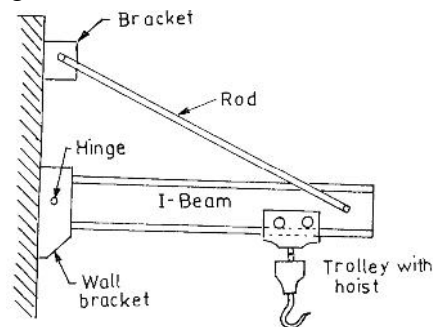

Fig. 7 Jib Crane

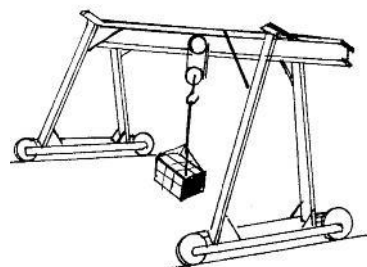

Fig. 6 Gantry Crane

**Transporting devices:** These devices are used for transporting the material in horizontal direction these are:

**1. Hand trucks/power trucks and wheel barrows.** The simplest transporting devices are wheel barrows and hand trucks. These are still in use in number of small industries all over the country. Fig. 8 shows a hand truck Fig. 9 shows a wheel barrow or a wheeler. Wheelers are particularly used to handle the materials inside the shops. Wheels are nothing but a form of a box provided with wheels. These equipment involve a large amount of manpower for a relatively small load. The chief advantage of this equipment is its very low cost its great flexibility, and its easy portability from one job to another. However, in many cases, power operated equipment should be substituted for equipment of this kind, which is mainly used because of tradition.

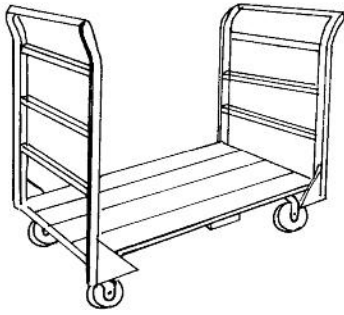

Fig. 8 Hand Truck



Fig. 9 Wheel Barrow

**2. Industrial railways.** Industrial railways are narrow-gauge rail roads. In general, little use is made of such equipment because it requires a heavy investment in the road bed and tracks. It possesses little flexibility, and is difficult to change after some period, if required. Industrial railways were used in the days before the development of rubber tire equipment. They are still found in metal working industries (blast furnaces, copper refineries and steel-rolling operations) and in mining activities, where it is cheaper or more desirable to lay tracks than to pave the entire area.

**3. Tractors and trailers.** (Fig. 10) The use of tractors and trailers for material handling is one of the most common method of horizontal transportation. This method is most flexible as tractors can be connected to different types of trailers. Trailers can be disconnected from tractors, left loaded and can be picked up by different tractors. This system thus has the advantage of great flexibility plus all the advantages of industrial railways, and there is no investment in laying tracks. It is one of the most important methods of handling materials inside the plant and from one building to another.



Fig. 10 Wheel Hydraulic Tripping Trailer

**4. Aerial tramways.** Aerial tramways are also a horizontal transportation system in which the load carrying vehicle is supported from the top, usually by means of a cable or its equivalent.

**5. Pipe Line.** Pipe lines and pumps are also used for horizontal transportation of commodities. Most obvious among these is oil, which is pumped great distances through pipe lines. Gas, principally natural gas, is also carried through pipe lines. Water is similarly transported at various distances.

**6. Skids.** Skids are used with lift trucks. Goods may be loaded on to skids and then picked up with lift trucks. This is the first improvement over wheel barrows and hand trucks. The skid can be transferred from position to position without subsequent loading and unloading. Both skids and pallets raise the load off the supporting surface and allow the easy insertion of the conveying means.



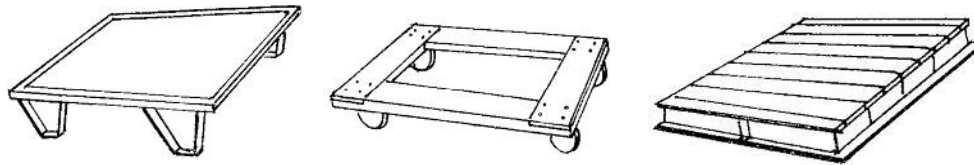

Fig. 11 Skids

**Devices which lift and transport** (Combination devices): These devices are used for lifting, transporting and lowering the material. These are:

**1. Slides and Chutes.** (Fig. 12) One of the simplest devices that have both vertical and horizontal motion is a slide or chute. It may be straight or spiral and is static in nature. Gravity is utilized in order to move material down and, if desired, to change the position of the load horizontally. Chutes are common in railway and air line terminal for handling packages and baggages. Chutes are also used in department stores particularly in spiral form to ship stock from reserves on the upper floors to the lower selling floors. Where the sliding down process tends to be slow, the vibrating chutes are used where the materials are moved downwards through vibrations.

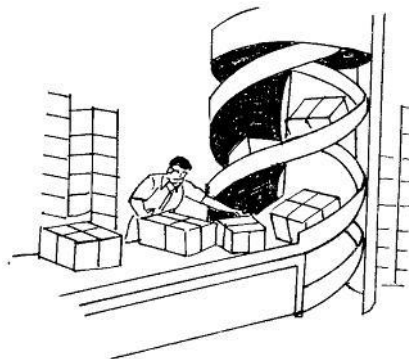

Fig. 12 Spiral Chute

**2 Monorails.** Monorail is an I-section beam attached to the ceiling and having a trolley hoist moving along it. The material can be transferred from one place to another along the beam. Either the vertical, or horizontal travel, or both, are power operated. This makes possible the handling of relatively heavy material by lifting the load and transporting it.

**3 Lifts.** In a multistoried plants material may be lifted up and transported by lifts. It is a fast and flexible equipment for floor to floor travel. Buckets or trays can be mounted on the endless chain running from the ground floor to the top floor. The material can be loaded on trays automatically.

**4 Trucks.** The trucks are used to move the heavy materials over varying paths. They are either manually operated or power operated. Generally two wheeler, three wheeler or four or more wheeler trucks are used to carry and to move heavy loads. Industrial trucks are preferred:

- when materials are to be picked up and moved intermittently on different routes.
- when materials are of mixed size and weight.
- when it is possible to use unit load.
- when cross traffic exists.
- when distances to be moved are moderate.

The various types of trucks used for material handling are manually operated trucks, power operated trucks, lift trucks (Fig. 13), fork lift trucks (Fig. 14), crane trucks (Fig. 15), auto trucks etc. The lifting feature in lift trucks provides clearance from the floor for the skids and permits horizontal transportation.

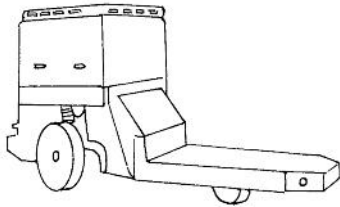

Fig. 13 Lift Truck

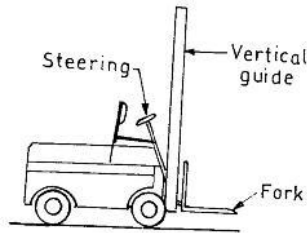

Fig. 14 Fork Lift Truck

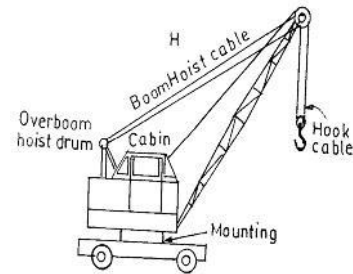

Fig. 15 Crane Truck

*Crane Truck.* Small crane trucks operate on the same principle as lift trucks. They are used for materials that cannot be put on skids, or is not available on skids at the present time, or is much too heavy to handle with lift trucks. It moves quickly over smooth, even and hard ground. It can be carried at will and to any place. In these cranes the solid rubber tyres are used. The cranes are rotary type, as shown in Fig. 15, so that the load can be lifted from any position.

*Auto Truck.* Auto trucks need no particular explanation except for the development of tail boards (hydraulic gates), which receives the load at ground level and elevate it to the level of the truck, so that all manual lifting is avoided.

**5. Conveyors.** A conveyor is a device which moves materials in either a vertical or horizontal direction between two fixed points. They may be fixed or portable conveyors, straight or circular ones. The materials are fed to the conveyor from some other source at the point of start; they are carried by the conveyor to the point of destination. They are driven with the help of power or without the power through gravity. Conveyors have the advantage that they largely save labour cost, but have the disadvantage that they take up considerable space, are relatively fixed and in most cases the investment cost is high.

Conveyors are used in mass production industries where unit loads are uniform, the required movement of the material is continuous, path and rate of movement of material is not likely to change. Conveyors have a number of uses, especially in a line layout. A good system of conveyors besides bringing about low cost transportation can also be employed for:

- i. processing activities performed during transportation;
- ii. work-holding devices on a moving work-station;
- iii. a medium for providing storage;
- iv. inspection of the product in transit;

Processing activities that can be performed on materials in transit include head treatment, baking, cleaning, painting, drying, hardening and cooling. Speed and uniformity in quality are obtained by automatic control in transit.

By special design of containers, racks and fixtures, the operators can perform a sequence of operations while the material is in transit, thus eliminating pick-up and put-away non-productive activities. The proper pre-positioning of the material in the work centre also

facilitates the use of both hands of the operator to good advantage. The material can also be inspected, sorted, graded, weighed, counted, checked for size, or tested for various attributes.

Power conveyors co-ordinate various operations at the required rate of movement, thus effecting means of pacing the work. As a pacing device, conveyors free the supervisors from the need to maintain the required rate of operations, which is executed automatically. Because there is a definite flow of work at a pre-determined rate in a chain of operations tied together, it is easy to attain detailed scheduling. Mechanized pacing facilitates better production control, with a reduced amount of detailed attention and paper work on the part of the planning personnel.

### Types of Conveyors

(a) **Roller Conveyor.** Roller conveyors are flat, circular or spiral. They consist of rollers supported in frames over which materials are allowed to move. They are driven through gravity. Generally materials having flat bottoms are moved, otherwise boxes or pallets are used.

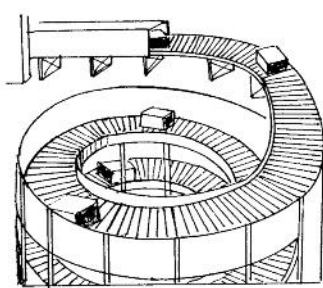

Fig. 16 Roller Spiral Conveyor

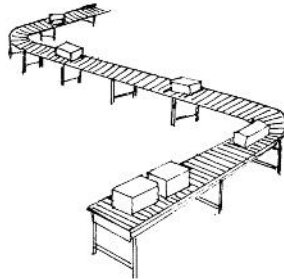

Fig. 17 Roller Conveyor

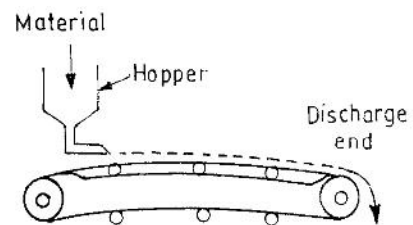

Fig. 17 Belt Conveyor

(b) **Belt conveyor.** Fig. 18 shows a belt conveyor, which consists of endless belt. It has a power driven pulley at one end which moves the belt continuously. It may be flat or elevated with upward or downward flow of materials. Generally, the belt is made from rubber, canvas, fabric, leather, perforated sheets or woven wires. The fixed or portable belt conveyors are used according to the requirements of the production processes.

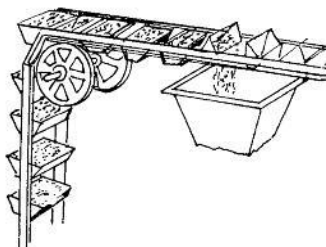
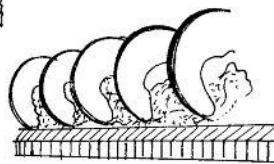
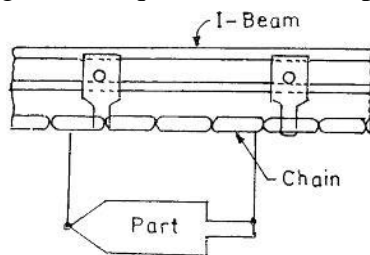

Fig. 19 Chain Conveyor Fig. 20 Screw Conveyor Fig. 21 Bucket Conveyor

(c) **Chain conveyor.** (Fig. 19) Chain conveyor consists of overhead mounted endless chain. It is supported from the ceiling and has a fixed path to travel. It saves valuable floor space. The arrangement is such that the lifting mechanism (may be an electromagnet or a hook) lowers down for loading and unloading of the products to be handled. Chain conveyors are used in refrigeration industries for painting and plating of the refrigerator shells.

**(d) Screw Conveyor.** (Fig. 20) Screw conveyors are used principally for transmitting materials in the form of powder or paste with the application of rotating screw. For example, feeding pulverized coal into a furnace.

**(e) Bucket conveyor.** (Fig. 21) Bucket conveyors are used to move the granular, powdered or liquid materials. The buckets may be mounted on a chain or a belt. The movement may be vertical or flat. The vertical movement may be continuous wherein buckets are hooked in a sequential circular manner or discrete where buckets are hooked for lifting.

#### **4.5 Group Technology (GT)**

Group technology is a manufacturing philosophy in which similar parts are identified and grouped together to take advantage of similarities in design and/or manufacture. Similar parts are grouped into part families. For example, a factory that produces as many as 10,000 different part numbers can group most of these parts into as few as 50 distinct part families. Since the processing of each family would be similar, the production of part families in dedicated manufacturing cells facilitates workflow. Thus, group technology results in efficiencies in both product design and process design.

##### **4.5.1 Part Family Formation**

The key to gaining efficiency in group-technology-based manufacturing is the formation of part families. A part family is a collection of parts that are similar either due to geometric features such as size and shape or because similar processing steps are required in their manufacture. Parts within a family are different, but are sufficiently similar in their design attributes (geometric size and shape) and/or manufacturing attributes (the sequence of processing steps required to make the part) to justify their identification as members of the same part family. The biggest problem in initiating a group-technology-based manufacturing system is that of grouping parts into families. Three methods for accomplishing this grouping are

1. Visual inspection. This method involves looking at the part, a photograph, or a drawing and placing the part in a group with similar parts. It is generally regarded as the most time consuming and least accurate of the available methods.
2. Parts classification and coding. This method involves examining the individual design and/or manufacturing attributes of each part, assigning a code number to the part on the basis of these attributes, and grouping similar code numbers into families. This is the most commonly used procedure for forming part families.
3. Production flow analysis. This method makes use of the information contained on the routing sheets describing the sequence of processing steps involved in producing the part, rather than part drawings. Workparts with similar or identical processing sequences are grouped into a part family.

##### **4.5.2 Parts Classification and Coding**

As previously stated, parts classification and coding is the most frequently applied method for forming part families. Such a system is useful in both design and manufacture. In particular, parts coding and classification, and the resulting coding system, provide a basis for interfacing CAD and CAM in CIM systems. Parts classification systems fall into one of three categories:

###### ***1. Systems based on part design attributes:***

- Basic external shape
- Basic internal shape
- Length/diameter ratio

Material type  
Part function  
Major dimensions  
Minor dimensions  
Tolerances  
Surface finish

**2. Systems based on part manufacturing attributes:**

Primary process  
Minor processes  
Major dimensions  
Length/diameter ratio  
Surface finish  
Machine tool  
Operation sequence  
Production time  
Batch size  
Annual production requirement  
Fixtures needed  
Cutting tools

**3. Systems based on a combination of design and manufacturing attributes.**

Although well over 100 classification and coding systems have been developed for group technology applications, all of them can be grouped into three basic types:

1. Hierarchical or monocode
2. Attribute, or polycode
3. Hybrid, or mixed

**Hierarchical Code**

In this type of code, the meaning of each character is dependent on the meaning of the previous character; that is, each character amplifies the information of the previous character. Such a coding system can be depicted using a tree structure as shown in Figure 22, which represents a simple scheme for coding the spur gear shown in Figure 1a. Using these figures, the code, "A11B2 can be assigned to the spur gear. A hierarchical code provides a large amount of information in a relatively small number of digits. Design departments frequently use hierarchical coding systems for part retrieval because this type of system is very effective for capturing shape, material, and size information. Manufacturing departments, on the other hand, have different needs which are often based on process requirements. It is difficult to retrieve and analyze process-related information when it is in a hierarchical structure that will be equally useful to both the design and manufacturing organizations.



Figure 22

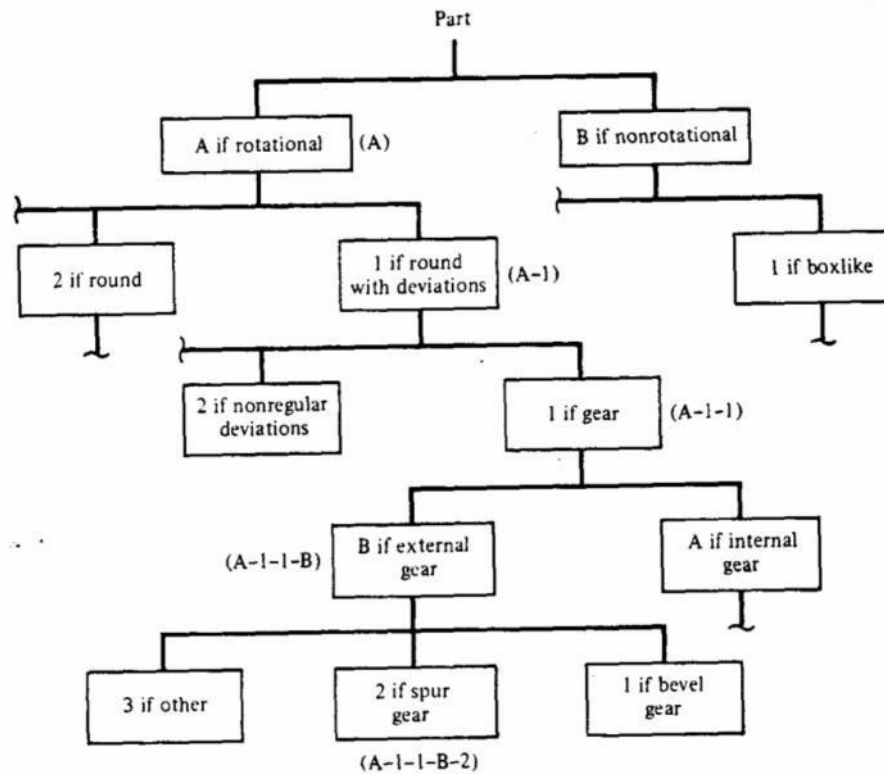

The **Opitz** system is perhaps the best known coding system used in parts classification and coding. The code structure is

**12345 6789 ABCD**

The first nine digits constitute the basic code that conveys both design and manufacturing data. The first five digits, 12345, are called the form code and give the primary design attributes of the part. The next four digits, 6789, constitute the supplementary code and indicate some of the manufacturing attributes of the part. The next four digits, ABCD, are called the secondary code and are used to indicate the production operations of type and sequence. Figure 37.12 gives the basic structure for the Opitz coding system. Note that digit 1 establishes two primary categories of parts, rotational and non-rotational, among nine separate part classes.

The **MICLASS** (Metal Institute Classification System) was developed by the Netherlands Organization for Applied Scientific Research to help automate and standardize a number of design, manufacturing, and management functions. MICLASS codes range from 12 to 30 digits, with the first 12 constituting a universal code that can be applied to any part. The remaining 18 digits can be made specific to any company or industry. The organization of the first 12 digits is as follows:

- 1st digit main shape
- 2nd and 3rd digits shape elements
- 4th digit position of shape elements
- 5th and 6th digits main dimensions
- 7th digit dimension ratio
- 8th digit auxiliary dimension
- 9th and 10th digits tolerance codes
- 11th and 12th digits material codes

MICLASS allows computer-interactive parts coding, in which the user responds to a series of questions asked by the computer. The number of questions asked depends on the complexity of the part and ranges from as few as 7 to more than 30, with an average of about 15.

The **CODE** system is a parts classification and coding system developed and marketed by Manufacturing Data System, Inc (MDSI), of Ann Arbor, Michigan. Its most universal application is in design engineering for retrieval of part design data, but it also has applications in manufacturing process planning, purchasing, tool design, and inventory control. The code number has eight digits. For each digit, there are 16 possible values (zero through 9 and A through F) which are used to describe the parts design and manufacturing characteristics. The initial digit position indicates the basic geometry of the part and is called the major division of the code system. This digit would be used to specify whether the shape was cylinder, flat, block, or other. The interpretation of the remaining digits forms a chain-type structure. Hence the CODE system possesses a hybrid structure.

#### 4.5.3 Clustering Analysis

- Based on the analysis of sequences of fabrication operations (*routings*) of parts.
- Parts that go through *similar operations* are grouped together into the same part families.
- Machines may then be grouped into *cells* that produce their respective part families.
- The analysis begins with forming a *machine-component matrix* which identifies which parts are processed on which machines.
- Clustering requires *accurate* and optimized *routings*.

#### 4.5.4 Benefits of Group Technology

Group technology offers substantial benefits to companies that have the perseverance to implement it. The benefits include:

- GT promotes standardization of tooling, fixturing and setups.
- Material handling is reduced because parts are moved within a machine cell rather than within the entire factory.
- Process planning and production scheduling are simplified
- Setup times are reduced, resulting in lower manufacturing lead times.
- Work-in-process is reduced.
- Worker satisfaction usually improves when workers collaborate in a OT cell.
- Higher quality work is accomplished using group technology.

#### 4.6 Computer Aided Process Planning (CAPP)

In manufacturing, the goal is to produce components that meet the design specifications. The design specification ensures the functionality aspect. Next step to follow is to assemble these components into final product. Process planning acts as a bridge between design and manufacturing. It translates design specifications into manufacturing process details. Hence, in general, process planning is a production organization activity that transforms a product design into a set of instruction (sequence, machine tool setup etc.) to manufacture machined part economically and competitively. The information provided in design includes dimensional specification (geometric shape and its feature) and technical specification (tolerance, surface finish etc.).

##### 4.6.1 Approaches to Process Planning

There are basically two approaches to process planning which are as follows:

- (i) Manual experience-based process planning, and
- (ii) Computer-aided process planning method.

### (i) Manual Experience-based Process Planning

The steps mentioned in the previous section are essentially same for manual process planning. Following difficulties are associated with manual experienced based process planning method:

- It is time consuming and over a period of time, plan developed are not consistent.
- Feasibility of process planning is dependent on many upstream factors (design and availability of machine tools). Downstream manufacturing activities such as scheduling and machine tool allocation are also influenced by such process plan.

Therefore, in order to generate a proper process plan, the process planner must have sufficient knowledge and experience. Hence, it is very difficult to develop the skill of the successful process planner and also a time consuming issue.

### (ii) Computer-Aided Process Planning

Computer-aided process planning (CAPP) helps determine the processing steps required to make a part after CAP has been used to define what is to be made. CAPP programs develop a process plan or route sheet by following either a variant or a generative approach. The variant approach uses a file of standard process plans to retrieve the best plan in the file after reviewing the design. The plan can then be revised manually if it is not totally appropriate. The generative approach to CAPP starts with the product design specifications and can generate a detailed process plan complete with machine settings. CAPP systems use design algorithms, a file of machine characteristics, and decision logic to build the plans. Expert systems are based on decision rules and have been used in some generative CAPP systems.

CAPP has recently emerged as the most critical link to integrated CAD/CAM system into inter-organizational flow. Main focus is to optimize the system performance in a global context. The essentiality of computer can easily be understood by taking an example, e.g. if we change the design, we must be able to fall back on a module of CAPP to generate cost estimates for these design changes. Similarly for the case of the breakdown of machines on shop floor. In this case, alternative process plan must be in hand so that the most economical solution for the situation can be adopted. Figure 9.2 is one such representation, where setting of multitude of interaction among various functions of an organization and dynamic changes that takes place in these sub functional areas have been shown. Hence, the use of computer in process planning is essential.

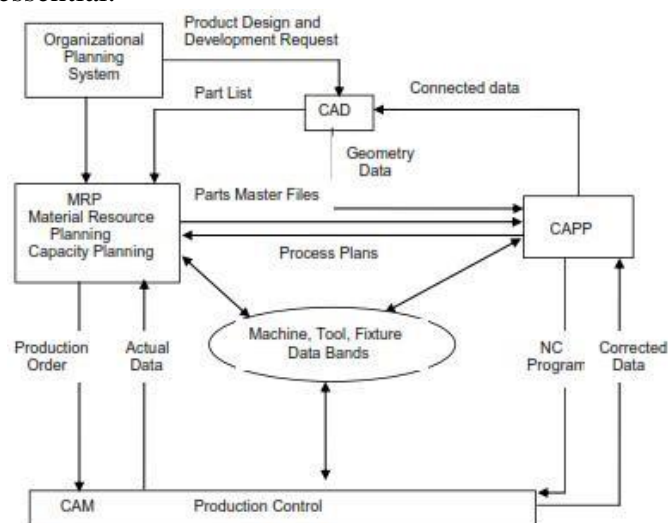

Figure 4.23 Framework for Computer Aided Process Planning



CAPP is the application of computer to assist the human process planner in the process planning function. In its lowest form it will reduce the time and effort required to prepare process plans and provide more consistent process plan. In its most advanced state, it will provide the automated interface between CAD and CAM and in the process achieve the complete integration with in CAD/CAM.

### Advantages Over Manual Experience-based Process Planning

The uses of computers in process plan have following advantages over manual experience-based process planning:

- (i) It can systematically produce accurate and consistent process plans.
- (ii) It leads to the reduction of cost and lead times of process plan.
- (iii) Skill requirement of process planner are reduced to develop feasible process plan.
- (iv) Interfacing of software for cost, manufacturing lead time estimation, and work standards can easily be done.
- (v) Leads to the increased productivity of process planner.

With the emergence of CIM as predominate thrust area in discrete part industries process planning has received significant attention, because it is the link between CAD and CAM. Hence, computer aided process planning (CAPP) has become a necessary and vital objective of CIM system.

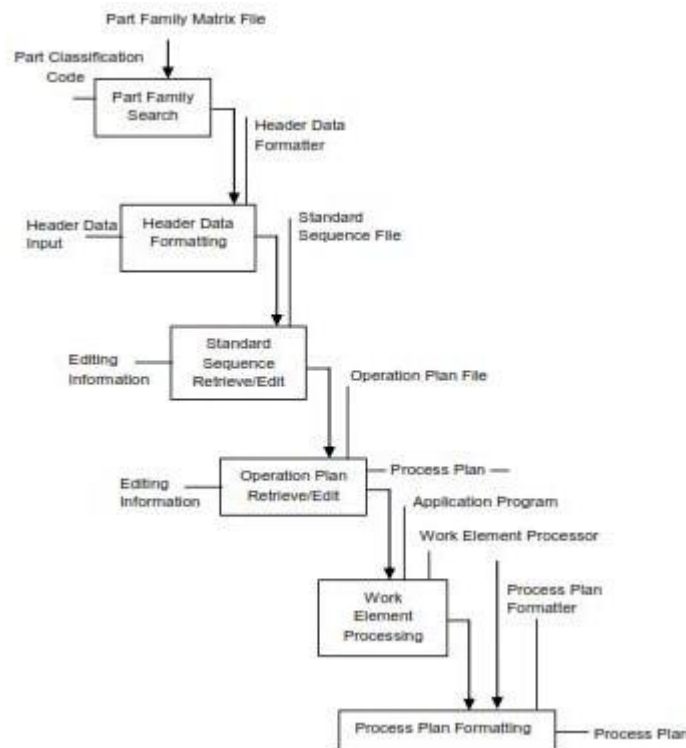

Figure 4.24: Flow Diagram of the CAPP Process Planning System

#### **4.6.2 Steps Involved in CAPP**

Now-a-days, rapid progress is being made in the automation of actual production process and also the product design element. However, the interface between design and production presents the greatest difficulty in accomplishing integration. CAPP has the potential to achieve this integration. In general, a complete CAPP system has following steps:

- (i) Design input
- (ii) Material selection
- (iii) Process selection
- (iv) Process sequencing,
- (v) Machine and tool selection,
- (vi) Intermediate surface determination
- (vii) Fixture selection,
- (viii) Machining parameter selection
- (ix) Cost/time estimation
- (x) Plan preparation
- (xi) Machine tape image generation.

#### **4.6.3 Approaches to Computer-Aided Process Planning**

In recent days, several computer-aided process planning systems are available for use for a variety of manufacturing operation. These systems can broadly be clarified into two categories:

- A. Variant computer aided process planning method.
- B. Generative computer aided process planning method.

##### **A. Variant type CAPP**

Variant process planning approach is sometimes referred as a data retrieval method. In this approach, process plan for a new part is generated by recalling, identifying and retrieving an existing plan for a similar part and making necessary modifications for new part. As name suggests a set of standard plans is established and maintained for each part family in a preparatory stage. Such parts are called master part. The similarity in design attributes and manufacturing methods are exploited for the purpose of formation of part families. Using coding and classification schemes of group technology (GT), a number of methods such as coefficient based algorithm and mathematical programming models have been developed for part family formation and plan retrieval. After identifying a new part with a family, the task of developing process plan is simple. It involves retrieving and modifying the process plan of master part of the family. The general steps for data retrieval modification are as follows:

A variant system usually begins with building a classification and coding scheme. Because, classification and coding provide a relatively easy way to identify similarity among existing and new parts. Today, several classification and coding systems are commercially available. In some extreme cases, a new coding scheme may be developed. If variant CAPP is preferred than it is useful for a company to look into several commercially available coding and classification systems (e.g. DCLASS, JD-CAPP etc.). Now, it is compared with companies before developing their own coding and classification system. Because using an existing system can save tremendous development time and manpower.

### **(i) Form the Part Families by Grouping Parts**

The whole idea of GT lies into group numerous parts into a manageable number of part families. One of the key issues in forming part families is that all parts in the same family should have common and easily identifiable machined features. As a standard process plan are attached with each part family, thereby reducing the total number of standard process plans.

### **(ii) Develop Standard Process Plans**

After formation of part families, standard process plan is developed for each part families based on common part features. The standard plan should be as simple as possible but detailed enough to distinguish it from other.

### **(iii) Retrieve and Modify the Standard Plans for New Parts**

Step1 to step 3 are often referred as preparatory work. Each time when a new part enters the systems, it is designed and coded based on its feature, using the coding and classification scheme, and then assigned to a part family. The part should be similar to its fellow parts in the same family. Also, family's standard plan should represent the basic set of processes that the part has to go through. In order to generate detailed process routes and operation sheets to this part, the standard plan is retrieved from the data base and modified. Modification is done by human process planar. After this stage parts are ready for release to the shop.

The success of aforementioned process planning system is dependent on selection of coding scheme, the standard process plan and the modification process, because the system is generally application oriented. It may be possible that one coding scheme is preferable for one company and same is not for other company.

Due to use and advancement of computers, the information management capability of variant process planning is much superior. Otherwise it is quite similar to manual experience-based planning.

### **Advantages of Variant CAPP**

Following advantages are associated with variant process planning approach:

- (i) Processing and evaluation of complicated activities and managerial issues are done in an efficient manner. Hence lead to the reduction of time and labour requirement.
- (ii) Structuring manufacturing knowledge of the process plans to company's needs through standardized procedures.
- (iii) Reduced development and hardware cost and shorter development time.
- (iv) This is an essential issue for small and medium scale companies, where product variety is not so high and process planner are interested in establishing their own process planning research activities.

### **Disadvantages of Variant CAPP**

Following disadvantages are associated with variant process planning approach

- (i) It is difficult to maintain consistency during editing.
- (ii) Proper accommodation of various combinations of attributes such as material, geometry, size, precision, quality, alternate processing sequence and machine loading among many other factors are difficult.
- (iii) The quality of the final process plan largely depends on the knowledge and experience of process planner. The dependency on process planner is one of the major shortcomings of variant process planning.

## **B. Generative type CAPP**

In generative process planning, process plans are generated by means of decision logic, formulas, technology algorithms, and geometry based data to perform uniquely processing decisions. Main aim is to convert a part from raw material to finished state. Hence, generative process plan may be defined as a system that synthesizes process information in order to create a process plan for a new component automatically.

Generative process plan mainly consists of two major components:

- (i) Geometry based coding scheme.
- (ii) Proportional knowledge in the form of decision logic and data.

### **Geometry-based Coding Scheme**

All the geometric features for all process such as related surfaces, feature dimension, locations, on the features are defined by geometry based coding scheme. The level of detail is much greater in generative system than a variant system. For example, various details such as rough and finished state of the part are provided to transform into desired state.

### **Proportional Knowledge in the Form of Decision Logic and Data**

Process knowledge in the form of decision logic and data are used for matching of part geometry requirement with the manufacturing capabilities. Operation instruction sets are automatically generated to help the operators to run the machines in case of manual operation. NC codes are automatically generated, when numerically controlled machines are used.

Manufacturing knowledge plays a vital role in process planning. The process of acquisition and documentation of manufacturing knowledge is a recurring dynamic phenomenon. In addition, there are various sources of manufacturing knowledge such experience of manufacturing personnel, handbooks, supplier of machine tools, tools, jigs and fixtures materials, inspection equipment and customers etc. Hence, in order to understand manufacturing information, ensuring its clarity and providing a framework for future modification, it is not only necessary but also inevitable to develop a good knowledge structure from wide spectrum of knowledge. Flowchart, decision trees, decision tables, algorithms, concepts of unit machined surfaces, pattern recognition techniques, and artificial intelligent based tools are used to serve the purpose.

### **Advantages of Generative Process Plan**

Generative process plans have a number of advantages. Among the major ones are the following:

- (i) They rely less on group technology code numbers since the process, usually uses decision tree to categorize parts into families.
- (ii) Maintenance and updating of stored process plans are largely unnecessary. Since, any plan may be quickly regenerated by processing through the tree. Indeed, many argue that with generable systems, process plans should not be stored since if the process is changed, and out-of-dated process plan might find its way back into the system.
- (iii) The process logic rules however must be maintained up to dated and ready for use. This provides the process planner with an assurance that the processes generated will reflect state-of-the-art technology.